

Technical Manual

WDGA absolute rotary encoders with EtherCAT interface

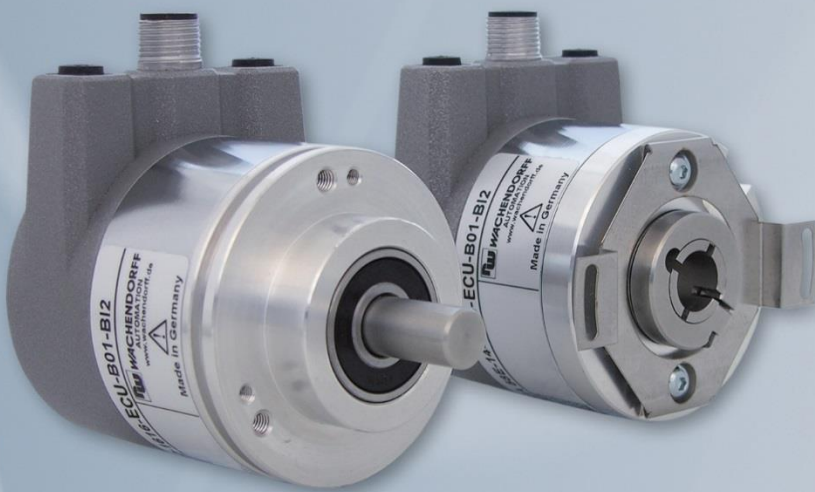

EnDra[®]
Technology

EtherCAT[®] 
Conformance tested



Industrie ROBUST

Legal information



Wachendorff Automation GmbH & Co. KG

Industriestrasse 7
65366 Geisenheim
Germany

Tel: +49 (0) 67 22 / 99 65 25

E-mail: support-wa@wachendorff.de

Website: www.wachendorff-automation.de

Wiesbaden District Court HRA 8377, VAT ID No: DE 814567094

Managing Director: Robert Wachendorff

Warranty waiver, right of amendment, copyright:

Wachendorff Automation accepts no liability or warranty for the correctness of this manual, or for any direct or indirect damage that may arise from it. In the pursuit of constant innovation and cooperation with customers, we reserve the right to amend technical data or content at any time.

Wachendorff Automation asserts copyright over this manual. It may not be modified, added to, reproduced or shared with third parties without prior written consent.

EtherCAT® is a registered trademark and patented technology, licensed by Beckhoff Automation GmbH, Germany.

Comments:

Should you have any corrections, notes or requests for changes, please send them to us. Send your comments to: support-wa@wachendorff.de

1	Introduction	1
1.1	About this manual.....	1
1.1.1	Explanation of symbols	2
1.1.2	What you will not find in this manual	2
1.2	Product assignment.....	3
1.3	Description of services	3
1.4	Supplied package	4
2	Safety information	5
2.1	General.....	5
2.2	Correct use	5
2.3	Safe working.....	6
2.4	Disposal.....	6
3	Description of the equipment	7
3.1	General.....	7
3.2	EtherCAT.....	7
3.3	Principles of WDGA.....	8
3.3.1	Single-turn - ST (QuattroMag®)	9
3.3.2	Multi-turn - MT (EnDra®)	9
3.3.3	Direction of revolution	9
3.3.4	Preset	9
3.3.5	Scaling	9
3.4	Things to consider when connecting EtherCAT encoders.....	11
3.4.1	BI2 - bus cover with 3 x M12x1	11
3.5	LEDs and signalling.....	12
3.6	MAC address and IP address.....	14
4	EtherCAT	15
4.1	Summary of functions.....	15
4.2	Communication protocols	15
4.3	CAN over EtherCAT (CoE).....	15
4.3.1	General	15
4.3.2	Communication-specific objects.....	16
4.3.2.1	1000h – Device type.....	19
4.3.2.2	1001h – Error register.....	19
4.3.2.3	1008h – Manufacturer device name	20

4.3.2.4	1010h – Store parameters.....	20
4.3.2.5	1011h – Restore parameters.....	20
4.3.2.6	1018h - Identity object	21
4.3.2.7	10F3h – Diagnosis history	21
4.3.2.8	1A00h – 1st TPDO mapping parameter	21
4.3.2.9	1A01h – 2nd TPDO mapping parameter	22
4.3.2.10	1C00h – Sync Manager communication type	23
4.3.2.11	1C13h – Sync Manager 3 PDO assignment	23
4.3.2.12	1C33h – Sync Manager 3 synchronisation	24
4.3.3	Manufacturer-specific objects	25
4.3.3.1	2105h – Integration values	26
4.3.3.2	2107h – Frequency limit	26
4.3.3.3	2120h – Customer flash area	26
4.3.3.4	2900h – IP address	26
4.3.3.5	2901h – Subnet mask.....	26
4.3.3.6	2902h – Gateway	26
4.3.4	Encoder-specific objects	26
4.3.4.1	6000h – Operating parameters.....	34
4.3.4.2	6001h – Measuring units per revolution.....	34
4.3.4.3	6002h – Total measuring range.....	34
4.3.4.4	6003h – Preset value.....	35
4.3.4.5	6004h – Position value	35
4.3.4.6	6008h – High-precision position value.....	35
4.3.4.7	6009h – High-precision preset value	35
4.3.4.8	600Ah – High-resolution total measuring range	35
4.3.4.9	600Bh – High-resolution position raw value	35
4.3.4.10	600Ch – Position raw value	35
4.3.4.11	6030h – Speed value.....	35
4.3.4.12	6031h – Speed parameters	36
4.3.4.13	6300h – CAM state register	36
4.3.4.14	6301h – CAM enable register	37
4.3.4.15	6302h – CAM polarity register	37
4.3.4.16	6310h ... 6317h – CAM1...CAM8 low limit.....	38
4.3.4.17	6320h ... 6327h – CAM1...CAM8 high limit.....	38
4.3.4.18	6330h ... 6337h – CAM1...CAM8 hysteresis.....	38
4.3.4.19	6340h ... 6347h – High-resolution CAM1...CAM8 low limit.....	38

4.3.4.20	6350h ... 6357h – High-resolution CAM1...CAM8 high limit.....	38
4.3.4.21	6360h ... 6367h – High-resolution CAM1...CAM8 hysteresis.....	38
4.3.4.22	6400h – Work area state register.....	39
4.3.4.23	6401h - Work area low limit	39
4.3.4.24	6402h – Work area high limit	39
4.3.4.25	6410h – High-resolution area state register	39
4.3.4.26	6411h – High-resolution work area low limit	39
4.3.4.27	6412h – High-resolution work area high limit.....	39
4.3.4.28	6500h – Operating status	39
4.3.4.29	6501h – Single-turn resolution.....	40
4.3.4.30	6502h – Number of distinguishable revolutions	40
4.3.4.31	6503h – Alarms.....	40
4.3.4.32	6504h – Supported alarms	40
4.3.4.33	6505h – Warnings.....	41
4.3.4.34	6506h – Supported warnings.....	41
4.3.4.35	6507h – Profile and software version.....	41
4.3.4.36	6508h – Operating time	42
4.3.4.37	6509h – Offset value.....	42
4.3.4.38	650Ah – Module identification.....	42
4.3.4.39	650Bh – Serial number	42
4.3.4.40	650Dh – Absolute accuracy	42
4.3.4.41	650Eh – Device capability	42
4.3.4.42	650Fh – Offset value for high-resolution encoder	42
4.3.4.43	6510h – Number of high-precision revolutions	43
5	Web server	44
5.1	General.....	44
5.2	Information	45
5.2.1	Summary.....	45
5.2.2	Diagnosis	46
5.2.3	Versions.....	47
5.3	Configuration	48
5.3.1	Network.....	48
5.3.2	Encoder.....	49
5.3.3	Firmware update	50
5.4	Licence information	53

5.5	Contact.....	53
6	TwinCAT 3.....	54
6.1	Commissioning.....	54
6.2	Scaling.....	57
6.3	Preset.....	59
6.4	Save settings.....	60
7	Technical advice.....	61

Index of figures

Figure 3.1: WDGA with EtherCAT bus cover	7
Figure 5.1: Web server – Summary	45
Figure 5.2: Diagnostics page	46
Figure 5.3: Versions	47
Figure 5.4: Network settings	48
Figure 5.5: Encoder information	49
Figure 5.6: Firmware update.....	50
Figure 5.7: Firmware update - selecting the file.....	50
Figure 5.8: Firmware update - transfer file.....	51
Figure 5.9: Firmware update – update FLASH	51
Figure 5.10: Firmware update - successful.....	52
Figure 5.11: Firmware update - failed	52
Figure 5.12: Licence information	53
Figure 5.13: Contact information	53
Figure 6.1: TwinCAT – Scan.....	54
Figure 6.2: TwinCAT - Scan / Message	55
Figure 6.3: TwinCAT - IO devices.....	55
Figure 6.4: TwinCAT – Scan for boxes	56
Figure 6.5: TwinCAT – Activate Free Run	56
Figure 6.6: TwinCAT - Scan complete	56
Figure 6.7: Scaling – Check object 6000	57
Figure 6.8: Scaling – set object 6000 to 4.....	57
Figure 6.9: Scaling – 6001 measuring units per revolution	58
Figure 6.10: Scaling – Total measuring range in measuring units	58
Figure 6.11: Scaling - Overview of the example settings	58
Figure 6.12: Preset – Set to zero.....	59
Figure 6.13: Preset – Preset accepted	59
Figure 6.14: Save settings	60

Index of tables

Table 3.1: Pin assignment	11
Table 3.2: LED signals.....	13
Table 4.1: Summary of the encoder's functions.....	15
Table 4.2: Communication protocols	15
Table 4.3: Object directory 1000h - 1018h.....	16
Table 4.4: Object directory 10F3h - 1A00h.....	17
Table 4.5: Object directory 1A01h - 1C00h.....	18
Table 4.6: Object directory 1C13h - 1C33h	19
Table 4.7: 1001h – Error register.....	19
Table 4.8: 1001h – Parameter storage options.....	20
Table 4.9: 1011h – Parameters loading options	20
Table 4.10: 1018h – Identity object.....	21
Table 4.11: 1010h – Identity object.....	21
Table 4.12: 1st transmit PDO default mapping (EtherCAT object 1A00h)	21
Table 4.13: Setup of sub-index 01 ... 08 of object 1A00h	22
Table 4.14: 2nd transmit PDO default mapping (EtherCAT object 1A01h)	22
Table 4.15: Sync Manager communication type (EtherCAT object 1C00h)	23
Table 4.16: Sync Manager 3 PDO assignment (EtherCAT Objekt 1C13)	23
Table 4.17: Sync Manager 3 synchronisation (EtherCAT Objekt 1C33h).....	24
Table 4.18: Manufacturer-specific objects 2105h - 2902h	25
Table 4.19: Integration values (EtherCAT object 2105h)	26
Table 4.20: Frequency limit (EtherCAT object 2107h).....	26
Table 4.21: Device-specific objects 6000h - 6031h	27
Table 4.22: Device-specific objects 6300h - 6314h	28
Table 4.23: Device-specific objects 6315h - 6327h	29
Table 4.24: Device-specific objects 6330h - 6336h	30
Table 4.25: Device-specific objects 6337h - 6402h	31
Table 4.26: Device-specific objects 6410h - 6508h	32
Table 4.27: Device-specific objects 6509h - 6510h	33
Table 4.28: Direction of revolution and scaling parameters	34
Table 4.29: Speed selector.....	36
Table 4.30: CAM state register - value 89h	36
Table 4.31: CAM state register - value 81h	37
Table 4.32: CAM enable register - value 4Ah.....	37
Table 4.33: Example of the CAM polarity register	37
Table 4.34: 6503h – Alarms.....	40
Table 4.35: Signal description	41
Table 4.36: Example of profile software version	41

1 Introduction

1.1 About this manual

This technical manual describes the configuration and assembly options for absolute encoders from Wachendorff Automation with an EtherCAT interface. It represents an addition to the other published Wachendorff Automation documents, such as the datasheets, assembly instructions, supplements, catalogues and flyers.

Read the manual before using the equipment. Check first that the version of the manual you have is the most recent.

When reading, pay particular attention to information, important and warning points that are marked with corresponding symbols (see 1.1.1).



This manual is designed for people with technical knowledge and experience of using sensors, EtherCAT interfaces and automation elements. If you do not have any experience of this equipment, please seek assistance from people who do.

Store the information supplied with our product carefully so that you can refer to it again at a later date if necessary.



- The contents of this manual are arranged with practical use in mind.
- All of the information in the following sections is required to get the best possible use out of the equipment, and should be read through thoroughly.

1.1.1 Explanation of symbols

	<ul style="list-style-type: none">• The INFO symbol is placed next to a section of text that is particularly informative or important for what to do next with the equipment.
	<ul style="list-style-type: none">• The IMPORTANT symbol is placed next to a section of text in which a process is described to resolve a particular problem.
	<ul style="list-style-type: none">• The WARNING symbol is placed next to a section of text that should be paid particular attention to in order to ensure the correct use of the equipment and to protect against danger.

1.1.2 What you will not find in this manual

- Principles of automation technology
- System planning
- Risks (availability, safety)
- Shielding concepts
- Reflections
- Repeaters
- Network configuration
- Bus cycle time
- FMA management services
- Transfer services
- Telegram types

1.2 Product assignment

This manual is assigned to the following types of encoder from Wachendorff Automation with the article designations below:

Absolute solid shaft encoder:

- WDGA 58A EtherCAT (BI2) – (with bus cover)
- WDGA 58B EtherCAT (BI2) – (with bus cover)
- WDGA 58D EtherCAT (BI2) – (with bus cover)
- WDGA 58F EtherCAT (BI2) – (with bus cover)

Absolute end hollow shaft encoder:

- WDGA 58E EtherCAT (BI2) – (with bus cover)



- The EtherCAT product range from Wachendorff can be found on our website: www.wachendorff-automation.de

1.3 Description of services

An encoder is a sensor used to capture angle positions (single-turn) and revolutions (multi-turn). The measuring data and variables derived from this are processed by the encoder and provided as electrical output signals for the downstream peripherals.

In the WDGA series, the patented technologies QuattroMag® and EnDra® are used for single-turn and multi-turn encoders respectively. This means that the WDGA series from Wachendorff is especially maintenance-free and environmentally friendly.

The encoders bearing the article designations described in Section 1.2 communicate via the EtherCAT interface.

1.4 Supplied package

The supplied package depends on the type of the design and your order. Before commissioning, you should check the supplied package for completeness.

Generally speaking, the WDGA product series with an EtherCAT interface comprises the following supplied package:

- WDGA with EtherCAT (with bus cover)
- Assembly instructions



- The corresponding ESI file and matching datasheet are available on the Internet to download: www.wachendorff-automation.de

2 Safety information

2.1 General

	<ul style="list-style-type: none">• The assembly instructions, the manual and the datasheet must all be read thoroughly before commissioning the encoder.• Failure to comply with the safety information can result in malfunctions, material damage and physical injury!• The machine manufacturer's operating instructions must be observed.
---	--

2.2 Correct use

Encoders are components designed for installation in machinery. Before commissioning (correct operation), it must be ensured that the machine as a whole complies with the EMC and Machinery directives.

The encoder is a sensor for capturing angle positions and revolutions and should only be used for such purposes! Encoders from Wachendorff Automation are produced and marketed for industrial use outside the safety/security sector.

	<ul style="list-style-type: none">• The encoder must not be operated outside the specified limit parameters (see associated datasheet).
---	---

2.3 Safe working

The installation and assembly of the encoder must be carried out exclusively by a qualified electrician.

National and international regulations applicable to the setup of electrical systems must be complied with.

If the encoder is not commissioned correctly, malfunctions or failures can occur.

	<ul style="list-style-type: none">• All electrical connections must be checked before commissioning.• Suitable safety measures should be deployed to ensure that, in the event of a failure or malfunction, no physical harm can occur and there is no damage to the system or operating facilities.
---	---

2.4 Disposal

Equipment that is no longer needed or which is faulty must be disposed of correctly by the user in accordance with country-specific legislation. It must be remembered that this equipment represents special electronic waste and it must not be disposed of in normal domestic waste.

The manufacturer is not obliged to take back the equipment. For questions relating to correct disposal, please contact a professional disposal company near you.

3 Description of the equipment

3.1 General

There are various mechanical versions of the WDGA series with EtherCAT. Crucial in this context is the design, with or without bus cover, the nature of the flange and the type of shaft (full or end hollow shaft). The size is specified by the diameter on the flange at 58 mm. The illustration below shows examples of the WDGA series with EtherCAT.

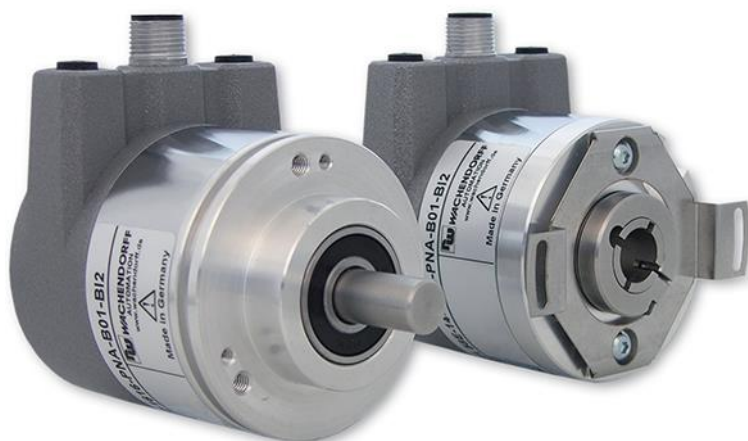

Figure 3.1: WDGA with EtherCAT bus cover

The full or end hollow shaft is linked to the revolving part whose angle position or speed is to be measured. Cable or plug outlets form the interface to the connection to the EtherCAT network. The status LEDs in the cover indicate the various states of the encoder during use. They support the configuration of the encoder or troubleshooting in the field. The flange drill holes or supplied spring plates are used to secure the encoder to the machine or while in use.

3.2 EtherCAT

EtherCAT is a real-time Ethernet technology that was originally discovered by Beckhoff Automation. The EtherCAT protocol published in the IEC standard IEC 61158 is suitable for hard as well as soft real-time requirements in automation technology, in measuring technology and in a number of other applications.

EtherCAT was unveiled in April 2003 and the EtherCAT Technology Group (ETG) was founded in November 2003. Meantime, the ETG has grown to become the largest industrial Ethernet and field bus user organisation in the world. The ETG brings manufacturers and users together who contribute to the technology's development in technical working groups.

The focal areas of EtherCAT's development were short cycle times ($\leq 100 \mu\text{s}$), low jitter for precise synchronisation ($\leq 1 \mu\text{s}$) and low hardware costs.

The telegram sent by the EtherCAT master runs through all network members. Every EtherCAT slave reads the output data addressed to it and places its input data in the forwarded data frame while the telegram is passing through the device. The telegram is only delayed by hardware cycle times. The last member in a segment (or branch) detects an open port and sends the telegram back to the master. The full duplex capability of Ethernet is used for this.

The maximum user data rate of a telegram is over 90%, while the theoretical effective data rate from the use of the full duplex capability is in excess of 100 Mbit/s ($> 90\%$ of two x 100 Mbit/s).

The EtherCAT master is the only member in the segment that can actively send an EtherCAT frame; all other members simply pass the frames on. This avoids unexpected delays and guarantees real-time compatibility.

The master uses a standard Ethernet medium access controller (MAC) without an additional communication processor. This means that a master can be installed on any hardware platform that provides an Ethernet port. The EtherCAT slaves use an EtherCAT slave controller (ESC) for processing in the cycle that is handled entirely in hardware. This means that network performance can be predicted and is independent of the individual slave device implementation. [*EtherCAT Technology Group, www.ethercat.org, 2017*]

Further information on EtherCAT can be found on the EtherCAT Technology Group's website at:

<https://www.ethercat.org>

3.3 Principles of WDGA

The sections below describe the basic functions on absolute encoder.

Unlike incremental encoders, absolute encoders output their position value as a digital number via a field bus. A distinction is made between single-turn and multi-turn encoders.

In addition to the simple output of the position value, most encoders also allow a certain degree of parametrisation, such as the choice of positive direction of revolution, the setting of the position value to a reference value at a defined physical position and scaling of the position value to a desired resolution and a limited measuring range. As a result, the amount of development work required in the control program is reduced, and the computing capacity of the control unit is relieved.

3.3.1 Single-turn - ST (QuattroMag®)

The measurement of the angle from 0° to 360° using a shaft is an encoder's simplest function. The sensors are based on the optical or magnetic scanning of a material measure on the encoder shaft.

The WDGA encoders from Wachendorff use the new magnetic QuattroMag® technology that ensures maximum accuracy and resolution of the single turn.

3.3.2 Multi-turn - MT (EnDra®)

A multi-turn encoder allows the number of revolutions to be recorded. This is carried out using a revolution counter. To ensure that the relevant information is retained even when the voltage is switched off, WDGA encoders use EnDra® technology. Buffer batteries and drives that require a relatively large amount of space and a corresponding amount of maintenance can therefore be replaced.

3.3.3 Direction of revolution

A simple two-part complement (invert each bit and add "1") of the position value can reverse the positive direction of revolution.

3.3.4 Preset

In a specific physical position, the encoder can be assigned a desired position value. This must be within the measuring range so that the position value correlates to a physical reference position. To do this, the difference between the current position value and the desired value is calculated. This is stored in a non-volatile memory and added to the position value as an offset.

3.3.5 Scaling

For the precise matching of the position value with the parameter to be measured in physical terms, adaptation can be carried out using the scaling parameters. The scalable parameters are "Measuring units per revolution (MUPR)" and "Total measuring range in measuring units (TMR)".

The scaling parameters "Measuring units per revolution (MUPR)" - increments per revolution - specify the resolution of the position value for each revolution (also: ST -resolution). The value equates to 360°. This means that, if a value of 3600 Cts is parametrised, the encoder outputs the position in 0.1° increments (see equation (2)).

$$MUPR = ST = 3600 \text{ Cts} \quad (1)$$

$$\text{angular steps} = \frac{\text{angle of one revolution}}{MUPR} = \frac{360^\circ}{3600 \text{ Cts}} = 0,1^\circ/\text{Cts} \quad (2)$$

The scaling parameter "Total measuring range in measuring units (TMR)" - maximum overall measuring range of the position value (single-turn and multi-turn multiplied) - indicates the encoder's overall resolution. Once the position value reaches TMR - 1, it skips back to 0 and vice versa.

Generally speaking, the TMR parameter is chosen so that it is a whole integer multiple of the "Measuring units per revolution (MUPR)" (see equation (4)), so that the zero point is always located at the same position on the encoder shaft.

$$TMR = 36000 \text{ Cts} \quad (3)$$

$$MT = \frac{TMR}{MUPR} = \frac{36000 \text{ Cts}}{3600 \text{ Cts}} = 10 \quad (4)$$

In exceptional cases, the TMR does not need to be a whole integer multiple of the MUPR. For example if a translation in a system causes the desired measuring parameter to move 10% faster in relation to the encoder shaft than the encoder shaft itself.

In this case, the setting of MUPR = 3960 Cts and TMR = 36000 Cts would ensure that the faster, but not directly measurable, shaft can be measured with a resolution of 0.1° and over a range of 10 revolutions. Normally, it would be possible to calculate the revolution speed by dividing the position value by the MUPR. In this case, however, it must be divided by 3600 Cts since the result would otherwise be the revolution speed of the encoder shaft and not the speed of the faster shaft in the system.



- It should be noted that measuring errors occur if the result of this formula is a decimal.

3.4 Things to consider when connecting EtherCAT encoders

3.4.1 BI2 - bus cover with 3 x M12x1

The "BI2" code in the order key refers to an encoder with a bus cover. The electrical connection is made at the bus cover via the 2 x M12 plugs and 1 x M12 socket. The connection assignment of the plugs and sockets can be found in Table 3.1.



Connection assignment		Connection assignment		Connection assignment	
BI2		BI2		BI2	
					
Socket (Port 1) IN	M12x1, 4-pin, D-coded	Plug (Power)	M12x1, 4-pin, A-coded	Socket (Port 2) OUT	M12x1, 4-pin, D-coded
Tx+	1	UB+	1	Tx+	1
Rx+	2	n. c.	2	Rx+	2
Tx-	3	UB-	3	Tx-	3
Rx-	4	n. c.	4	Rx-	4

Table 3.1: Pin assignment

3.5 LEDs and signalling

Four status LEDs in the cover indicate the various states of the encoder and support diagnosis and troubleshooting in the field (see Table 3.2). The two Link Activity LEDs (L/A) light up or flash green if the encoder is connected to another EtherCAT node (SPS, switch, other field device, etc.) and data is being exchanged. The MOD LED indicates operation, always lighting up green when the supply voltage is connected. The STAT LED indicates the EtherCAT status. Red signals in the STAT LED indicate errors, while green ones indicate the bus status. The green signals are always displayed in the pause between the red signals. This means that, in the event of uncertainty, the red signals take priority.

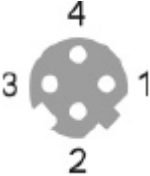
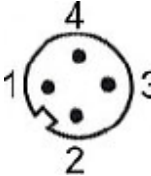
Run flashing signals:

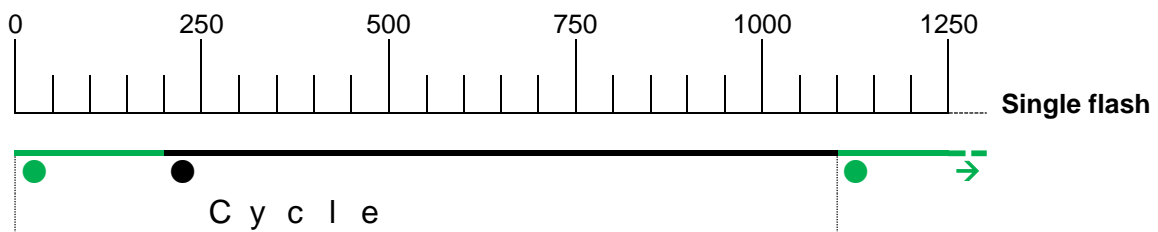
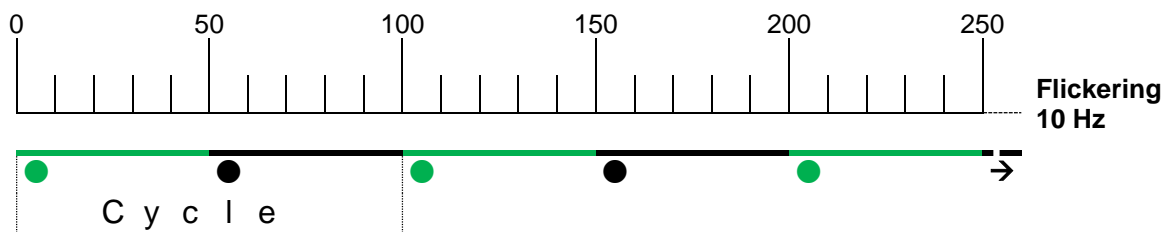
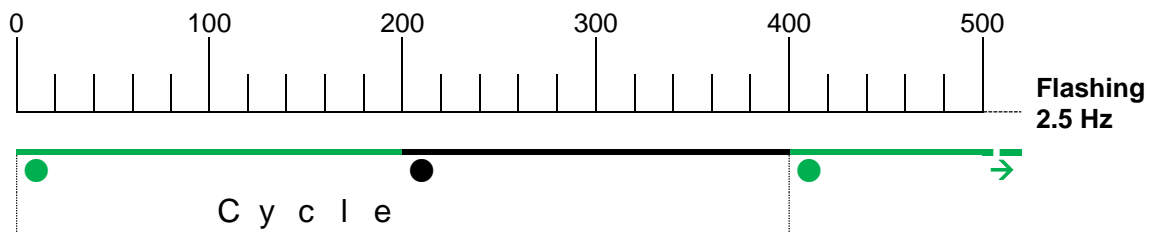

Error flashing signals:

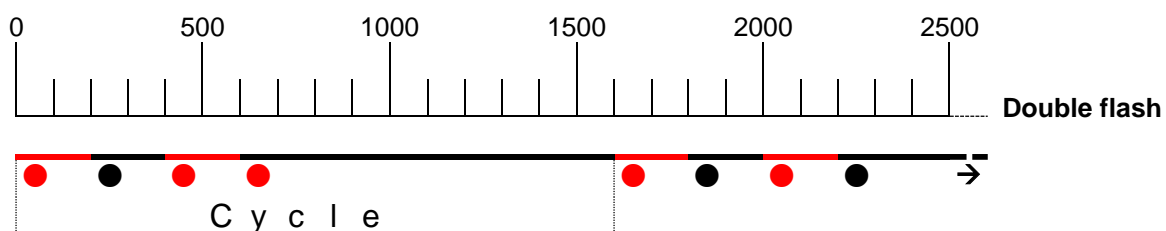
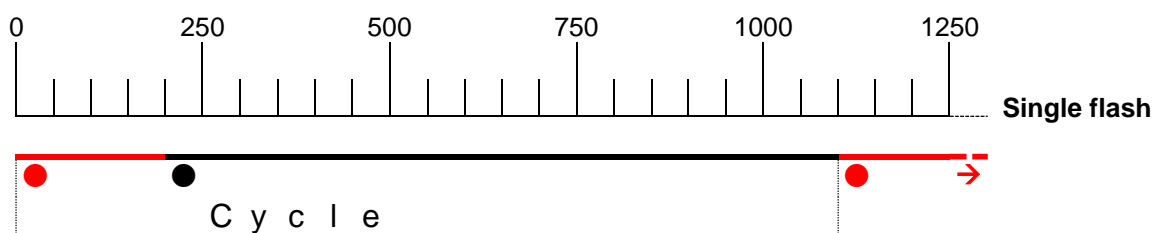
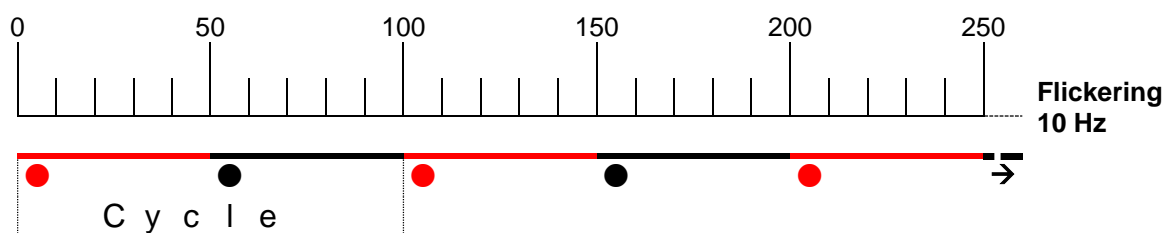
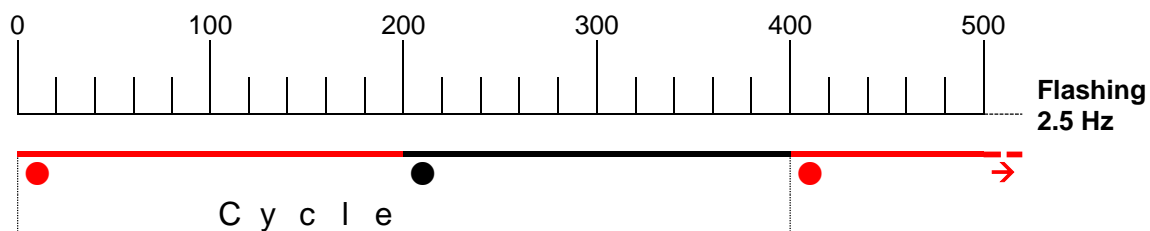

Colour	Function	Status	Meaning
Red	Error	Off	No error
		Flashing	Invalid configuration
		Single flash	Local error
		Double flash	Process data or EtherCAT watchdog timeout
		Flickering	Boot error
		On	Application error
Green	Run	Off	Initialisation
		Flashing	Pre-operational
		Single flash	Safe - operational
		Flickering	Initialisation or bootstrap
		On	Operational

Table 3.2: LED signals

3.6 MAC address and IP address

The Wachendorff EtherCAT encoder has a MAC address. This always starts with D4-90-E0-xx-xx-xx.

In its shipped status, the EtherCAT encoder has the IP address of 192.168.1.127. The IP address can be configured on the webpage of encoder, see subsection 5.3.1. The currently configured IP address can be determined using TwinCAT EoE settings or by reading objects 2900h..2902h.

4 EtherCAT

4.1 Summary of functions

Expansion stage	EtherCAT Slave V1.0.3
Protocols:	CoE (CAN over EtherCAT) EoE (Ethernet over EtherCAT) FoE (File Access over EtherCAT)
Profiles	Communication Profile Area CiA-406 compatible (encoder class C3)
Web server	Standard web server
Further features	Distributed clocks Sync Manager Outputs (SM3) SDO upload/download SDO information services Station alias Diagnosis processing

Table 4.1: Summary of the encoder's functions

4.2 Communication protocols

Protocol	Purpose
CoE	Implementation of the CiA device profile 406 for encoders
EoE	Web server interface
FoE	Firmware update via EtherCAT

Table 4.2: Communication protocols

4.3 CAN over EtherCAT (CoE)

4.3.1 General

The CANopen objects are listed below.

4.3.2 Communication-specific objects

The communication-specific objects follow the CiA 301 V4.02 specification and can contain the object addresses 1000h to 1FFFh at most.

Object	Name	Idx	Description	Data size (bit)	ro rw co	Map	Default
1000h	Device type	0h	MSB = encoder type; LSB = device profile No.	Unsigned32	co	no	Multi-turn: 0002 0196h Single turn: 0001 0196h
1001h	Error register	0h	Signalling of internal errors	Unsigned8	ro	Yes	00h
1008h	Manufacturer device name	00h	Manufacturer device designation	string256	co	no	WDGA-ST-EC WDGA-MT-EC
1009h	Manufacturer hardware version	00h	Contains the devices' hardware version	string16	co	co	
100Ah	Manufacturer software version	00h	Contains the devices' software version	string72	co	no	
1010h	Store parameters	00h	Saves object directory settings	Unsigned8	co	no	04h
		01h	All object directory content	Unsigned32	rw		0000 0001h
		02h	Communication-specific content	Unsigned32	rw		0000 0001h
		03h	Application-specific content	Unsigned32	rw		0000 0001h
		04h	Manufacturer-specific content	Unsigned32	rw		0000 0001h
1011h	Restore default parameters	00h	Restores factory settings	Unsigned8	co	no	04h
		01h	All object directory content	Unsigned32	rw		0000 0001h
		02h	Communication-specific content	Unsigned32	rw		0000 0001h
		03h	Application-specific content	Unsigned32	rw		0000 0001h
		04h	Manufacturer-specific content	Unsigned32	rw		0000 0001h
1018h	Identity object	00h	Data for product identification	Unsigned8	co	no	04h
		01h	Vendor ID	Unsigned32	ro		0000 021Fh
		02h	Product code (WDGA)	Unsigned32	ro		5744 4741h
		03h	Revision number	Unsigned32	ro		
		04h	Serial number	Unsigned32	ro		

Table 4.3: Object directory 1000h - 1018h

Object	Name	Idx	Description	Data size (bit)	ro rw co	Map	Default
10F3h	Diagnosis history	00h	Contains the last 5 diagnosis messages	Unsigned8	rw	no	05h
		01h	Max. Nr. of messages	Unsigned8	ro		20h
		02h	Subindex of recent message	Unsigned8	ro		00h
		03h	Subindex of last confirmed message	Unsigned8	ro		00h
		04h	New message	Bool	ro		false
		05h	Flags	Unsigned16	ro		0000h
		06h	Message 1..32	Unsigned64	ro		0000 0000h
		.. 25h					
1A00h	1st TPDO mapping parameter	00h	Defines the PDO mapping for the first TPDO	Unsigned8	rw	no	05h
		01h	1st Output object Default object: 6004h Position value	Unsigned32	rw		6004 0020h
		02h	2nd Output object, Default: 6030h Speed	Unsigned32	rw		6030 0110h
		03h	3rd Output object, Default: 6503h Alarms	Unsigned32	rw		6503 0010h
		04h	4th Output object, Default: 6505h Warnings	Unsigned32	rw		6505 0010h
		05h	5th Output object Default: 1001h Error register	Unsigned32	rw		1001 0008h
	<i>Inactive through sub-index 00h</i>	06h to 08h	Mapping of object 6-8 in the application	Unsigned32	rw		

Table 4.4: Object directory 10F3h - 1A00h

Object	Name	Idx	Description	Data size (bit)	ro rw co	Map	Default
1A01h	2nd TPDO mapping parameter	00h	Defines the PDO mapping for the 2nd TPDO	Unsigned8	rw	no	06h
		01h	1st Output object Default object: 6008h High-resolution position value	Unsigned32	rw		6008 0030h
		02h	2nd Output object, Default: 6030h Speed	Unsigned32	rw		6030 0110h
		03h	3rd Output object, Default: 6503h Alarms	Unsigned32	rw		6503 0010h
		04h	4th Output object, Default: 6505h Warnings	Unsigned32	rw		6505 0010h
		05h	5th Output object, Default: 6300h CAM state	Unsigned32	rw		6300 0108h
		06h	6th Output object, Default: 6410h High-resolution work area state	Unsigned32	rw		6410 0108h
	<i>Inactive through sub-index 00h</i>	07h to 08h	Mapping of object 7-8 in the application	Unsigned32	rw		0000 0000h
1C00h	Sync Manager Communication Type	00h	Sync Manager Configuration of communication channels	Unsigned8	ro	no	04h
		01h	Communication type SM0	Unsigned8	ro		01h
		02h	Communication type SM1	Unsigned8	ro		02h
		03h	Communication type SM2	Unsigned8	ro		03h
		04h	Communication type SM3	Unsigned8	ro		04h

Table 4.5: Object directory 1A01h - 1C00h

Object	Name	Idx	Description	Data size (bit)	ro rw co	Map	Default
1C13h	Sync Manager 3 PDO Assignment	00h	Sync Manager PDO configuration	Unsigned8	ro	no	02h
		01h	PDO mapping object index of TxPDO1	Unsigned16	ro		1A00h
		02h	PDO mapping object index of TxPDO2	Unsigned16	ro		1A01h
1C33h	Sync Manager 3 Synchronization	00h	Sync Manager 3 configuration of synchronization	Unsigned8	ro	no	20h
		01h	Synchronization type	Unsigned16	ro		0001h
		02h	Cycle Time	Unsigned32	ro		0000 0000h
		04h	Synchronization types supported	Unsigned16	ro		0007h
		05h	Minimum cycle Time	Unsigned32	ro		0000 C350h
		06h	Calc and Copy Time	Unsigned32	ro		0001 7AE8j
		0A h	Sync0 Cycle Time	Unsigned32	ro		0000 0000h
		0C h	Cycle Time too small	Unsigned16	ro		0000h
		20h	Sync Error	Bool	ro		false

Table 4.6: Object directory 1C13h - 1C33h

4.3.2.1 1000h – Device type

The device profile can be queried using the index 1000h. Only sub-index 0 is supported. Default values are:

- 0701 0196h - for single-turn encoders
- 0702 0196h - for multi-turn encoders

4.3.2.2 1001h – Error register

Content of object 1001h (bit allocation - meaning, default = 00000000b):

Bit:	7	6	5	4	3	2	1	0
Info:	0	0	0	0	0	0	0	generic error

Table 4.7: 1001h – Error register

4.3.2.3 1008h – Manufacturer device name

The device designation can be queried using the index 1008h. Only sub-index 0 is supported. The value of the object depends on the firmware variant.

- WDGA-ST-EC - for single-turn EtherCAT
- WDGA-MT-EC - for multi-turn EtherCAT

4.3.2.4 1010h – Store parameters

Parameters can be stored using the index 1010h.

Sub-index	Access	Meaning
0	co	Number of objects
1	Where	Save all parameters
2	Where	Save communication objects
3	Where	Save application objects
4	Where	Save manufacturer objects

Table 4.8: 1001h – Parameter storage options

	<ul style="list-style-type: none"> • Saving is initiated by populating the corresponding sub-index with the "ASCII" value "save" (in hex: 65766173h).
---	--

4.3.2.5 1011h – Restore parameters

The factory setting can be restored via index 1011h.

Sub-index	Access	Meaning
0	co	Number of objects
1	Where	Restore all parameters
2	Where	Restore communication objects
3	Where	Restore application objects
4	Where	Restore manufacturer objects

Table 4.9: 1011h – Parameters loading options

	<ul style="list-style-type: none"> • The loading of original parameters is initiated by populating the corresponding sub-index with the ASCII value "load" (in hex: 6C6F6164h).
---	--

4.3.2.6 1018h - Identity object

Sub-index	Access	Meaning
0	rw	Number of mapped objects default value: 4
1	rw	Vendor ID
2	rw	Product code
3	rw	Revision number
4	rw	Serial number

Table 4.10: 1018h – Identity object

4.3.2.7 10F3h – Diagnosis history

Sub-index	Type	Access	Meaning
0	Unsigned8	ro	Nr. of objects Value: 5..37
1	Unsigned8	ro	Max. nr. of messages Wert: 32
2	Unsigned8	ro	Subindex of recent message
3	Unsigned8	rw	Subindex of last confirmed message
4	BOOL	ro	New message flag
5	Unsigned16	rw	Flags
6...37	Unsigned64	ro	Messages 1 ... 32

Table 4.11: 1010h – Identity object

4.3.2.8 1A00h – 1st TPDO mapping parameter

The first transmit PDO can be dynamically configured. The standard mapping of the first PDO is listed in the table below.

Sub-idx	Access	Meaning
00	rw	Number of mapped objects Default value: 5
01	rw	1st Output object Default object: 6004h Position value
02	rw	2nd Output object, Default: 6030h Speed
03	rw	3rd Output object, Default: 6503h Alarms
04	rw	4th Output object, Default: 6505h Warnings
05	rw	5th Output object, Default: 1001h Error register

Table 4.12: 1st transmit PDO default mapping (EtherCAT object 1A00h)

Setup of sub-index 01...08:

1A00h	Sub-index 01...08		
Bit	31 ... 16	15 ... 8	7 ... 0
Contents			
31 ... 16	Index of the mapped object		
15 ... 8	Sub-index of the mapped object		
7 ... 0	Length of the mapped objects in bits		

Table 4.13: Setup of sub-index 01 ... 08 of object 1A00h

4.3.2.9 1A01h – 2nd TPDO mapping parameter

The second transmit PDO can also be dynamically configured. The standard mapping of the second PDO is listed in the table below. Here too, the sub-indices are set up as in Table 4.13.

Sub-idx	Access	Meaning
00	rw	Number of mapped objects Default value: 6
01	rw	1st Output object Default object: 6008h High-resolution position value
02	rw	2nd Output object, Default: 6030h Speed
03	rw	3rd Output object, Default: 6503h Alarms
04	rw	4th Output object, Default: 6505h Warnings
05	rw	5th Output object, Default: 6300h CAM state
06	rw	6th Output object, Default: 6410h High-resolution work area state

Table 4.14: 2nd transmit PDO default mapping (EtherCAT object 1A01h)

4.3.2.10 1C00h – Sync Manager communication type

Sub-Idx	Type	Access	Meaning
0	Unsigned8	ro	Nr. of objects Value: 4
1	Unsigned8	ro	Communication type SM0 Value: 1, Mailbox receive (Master to Slave)
2	Unsigned8	ro	Communication type SM1 Value: 2, Mailbox send (Slave to Master)
3	Unsigned8	ro	Communication type SM2 Value: 3, Rx PDO
4	Unsigned8	ro	Communication type SM3 Value: 4, Tx PDO

Tabelle 4.15: Sync Manager communication type (EtherCAT object 1C00h)

4.3.2.11 1C13h – Sync Manager 3 PDO assignment

Sub-Idx	Type	Access	Meaning
0	Unsigned8	ro	Nr. of objects Value: 2
1	Unsigned16	ro	PDO mapping Object Index of assigned TxPDO 1 Value: 1A00h
2	Unsigned16	ro	PDO mapping Object Index of assigned TxPDO 1 Value: 1A01h

Tabelle 4.16: Sync Manager 3 PDO assignment (EtherCAT Objekt 1C13)

4.3.2.12 1C33h – Sync Manager 3 synchronisation

Sub-Idx	Type	Access	Meaning	Value
0	Unsigned8	ro	Nr. of objects	32
1	Unsigned16	ro	Synchronization Type 0: Free Run 1: SM-Modus, synchronous with SM3 Event 2: DC-Modus, synchronous with Sync0 Event	1
2	Unsigned32	ro	Cycle time in ns	0
4	Unsigned16	ro	Synchronization Types Supported Bit 0: Free Run Bit 1: Sync-SM-Event Bit 2..4: Sync-Mode Bit 5..6: Shift-Mode Bit 7..15: Reserved	7
5	Unsigned32	ro	Minimum Cycle Time in ns	50000
6	Unsigned32	ro	Calc and Copy Time	97000
10	Unsigned32	ro	Sync0 Cycle Time	0
12	Unsigned16	ro	Cycle Time Too Small	0
32	Bool	ro	Sync Error	0

Table 4.17: Sync Manager 3 synchronisation (EtherCAT Objekt 1C33h)

4.3.3 Manufacturer-specific objects

The objects 2000h to 5FFFh are manufacturer-specific and are not defined by the CiA.

Object	Name	Idx	Description	Data size (bit)	ro rw co	Map	Default
2105h	Integration value	00h	Sensor settings	Unsigned8	ro	no	06h
		01h	Position filter	Unsigned8	rw		08h
		02h	Reserved	Unsigned32	ro		0000 0000h
		03h	Position hysteresis	Unsigned8	rw		08h
2107h	Frequency limit	00h	Limit for speed value	Unsigned16	rw	no	FFFFh
2120h	Customer Flash area	00h	Object for saving random data	Unsigned8	co	no	08h
		01h	Customer data 1	Unsigned32	rw		0000 0000h
		02h	Customer data 2	Unsigned32	rw		0000 0000h
		03h	Customer data 3	Unsigned32	rw		0000 0000h
		04h	Customer data 4	Unsigned32	rw		0000 0000h
		05h	Customer data 5	Unsigned32	rw		0000 0000h
		06h	Customer data 6	Unsigned32	rw		0000 0000h
		07h	Customer data 7	Unsigned32	rw		0000 0000h
		08h	Customer data 8	Unsigned32	rw		0000 0000h
2900h	IP address	00h	Contains the IP address	Unsigned8	co	no	04h
		01h	1st octet	Unsigned8	ro		C0h = 192
		02h	2nd octet	Unsigned8	ro		A8h = 168
		03h	3rd octet	Unsigned8	ro		01h = 1
		04h	4th octet	Unsigned8	ro		7Fh = 127
2901h	Subnet mask	00h	Contains the subnet	Unsigned8	co	no	
		01h	1st octet	Unsigned8	ro		FFh = 255
		02h	2nd octet	Unsigned8	ro		FFh = 255
		03h	3rd octet	Unsigned8	ro		FFh = 255
		04h	4th octet	Unsigned8	ro		00h = 0
2902h	Gateway	00h	Contains the gateway	Unsigned8	co	no	
		01h	1st octet	Unsigned8	ro		00h
		02h	2nd octet	Unsigned8	ro		00h
		03h	3rd octet	Unsigned8	ro		00h
		04h	4th octet	Unsigned8	ro		00h

Table 4.18: Manufacturer-specific objects 2105h - 2902h

4.3.3.1 2105h – Integration values

Sub-idx	Type	Access	Description
0	Unsigned8	ro	Sensor settings
1	Unsigned8	rw	Position filter Length of position filter value
2	Unsigned32	ro	Reserved
3	Unsigned16	Rw	Position hysteresis Hysteresis of position value

Table 4.19: Integration values (EtherCAT object 2105h)

4.3.3.2 2107h – Frequency limit

Sub-idx	Access	Description
00	rw	If this limit speed is exceeded, bit 0 is set in object 6505 (frequency limit exceeded). The unit is revolutions per second.

Table 4.20: Frequency limit (EtherCAT object 2107h)

4.3.3.3 2120h – Customer flash area

Users can save their own data in this area up to a size of 8 x 32 bits. This can be used for internal article codes, etc., for example.

4.3.3.4 2900h – IP address

Contains the encoder's IP address. Default: 192.168.1.127

4.3.3.5 2901h – Subnet mask

Contains the encoder's subnet mask. Default: 255.255.255.0

4.3.3.6 2902h – Gateway

Contains the encoder's gateway address. Default: 0.0.0.0

4.3.4 Encoder-specific objects

The encoder-specific objects follow the CiA encoder profile 406 and can contain the object addresses 6000h to 9FFFh at most.

Object	Name	Idx	Description	Data size (bit)	ro rw co	Map	Default
--------	------	-----	-------------	-----------------	----------------	-----	---------

6000h	Operating parameters	00h	Change/display of the operating parameters	Unsigned16	rw	no	0000h	
6001h	Measuring units per revolution	00h	Change of the single-turn resolution	Unsigned32	rw	no	0001 0000h	
6002h	Total measuring range	00h	Change of the overall resolution	Unsigned32	rw	no	FFFF FFFFh	
6003h	Preset value	00h	Change / display of a preset value for zero point adaptation	Unsigned32	rw	no	0000 0000h	
6004h	Position value	00h	Output value of the position (ST + MT)	Unsigned32	ro	Yes		
6008h	High-precision position value	00h	Output of the position if measuring range > 32 bit	Unsigned64	ro	Yes		
6009h	High-precision preset value	00h	Change / display of the high-precision preset value for zero point adaptation	Unsigned64	rw	no	0000 0000 0000 0000h	
600Ah	High-resolution total measuring range	00h	Like object 6002h only for 64-bit	Unsigned64	rw	no	0800 0000 0000 0000h	
600Bh	High-resolution position raw value	00h	Unscaled 64-bit position value without preset	Unsigned64	ro	no		
600Ch	Position raw value	00h	Unscaled 32-bit position value without preset	Unsigned32	ro	Yes		
6030h	Speed value	00h	Speed	Unsigned8	ro	Yes	01h	
		01h	Current speed value	Signed16	ro			
6031h		Speed parameter	00h	Speed parameter	Unsigned8	co	no	04h
			01h	Speed source selector	Unsigned8	rw	no	03h
		02h	Speed integration time	Unsigned16	rw	no	64h	
		03h	Multiplier value	Unsigned16	rw	no	01h	
		04h	Divider value	Unsigned16	rw	no	01h	

Table 4.21: Device-specific objects 6000h - 6031h

Object	Name	Idx	Description	Data size (bit)	ro rw co	Map	Default
6300h	CAM state register	00h	Display of the status of the cams	Unsigned8	ro	Yes	01h
		01h	Cam status (bit-wise coding: 0b = inactive, 1b = active)	Unsigned8	ro		00000000b
6301h	CAM enable register	00h	Enabling or disabling of individual cams	Unsigned8	ro	no	01h

		01h	Cam enabler or disabler (bit-wise coding: 0b = inactive, 1b = active)	Unsigned8	rw		0000000b
6302h	CAM polarity register	00h	Logic inversion of individual camps in the relevant CAM status (1b: inactive <=> active)	Unsigned8	ro	no	01h
		01h	CAM polarity 0b = CAM status not inverted, 1b = CAM status inverted	Unsigned8	rw		0000000b
6310h	CAM1 low limit	00h	Lower switching point for the 1st CAM	Unsigned8	co	no	01h
		01h	Change of the lower switching point for the 1st CAM	Signed32	rw		0000 0000h
6311h	CAM2 low limit	00h	Lower switching point for the 2nd CAM	Unsigned8	co	no	01h
		01h	Change of the lower switching point for the 2nd CAM	Signed32	rw		0000 0000h
6312h	CAM3 low limit	00h	Lower switching point for the 3rd CAM	Unsigned8	co	no	01h
		01h	Change of the lower switching point for the 3rd CAM	Signed32	rw		0000 0000h
6313h	CAM4 low limit	00h	Lower switching point for the 4th CAM	Unsigned8	co	no	01h
		01h	Change of the lower switching point for the 4th CAM	Signed32	rw		0000 0000h
6314h	CAM5 low limit	00h	Lower switching point for the 5th CAM	Unsigned8	co	no	01h
		01h	Change of the lower switching point for the 5th CAM	Signed32	rw		0000 0000h

Table 4.22: Device-specific objects 6300h - 6314h

Object	Name	Idx	Description	Data size (bit)	ro rw co	Map	Default
6315h	CAM6 low limit	00h	Lower switching point for the 6th CAM	Unsigned8	co	no	01h
		01h	Change of the lower switching point for the 6th CAM	Signed32	rw		0000 0000h
6316h	CAM7 low limit	00h	Lower switching point for the 7th CAM	Unsigned8	co	no	01h
		01h	Change of the lower switching point for the 7th CAM	Signed32	rw		0000 0000h
6317h	CAM8 low limit	00h	Lower switching point for the 8th CAM	Unsigned8	co	no	01h
		01h	Change of the lower switching point for the 8th CAM	Signed32	rw		0000 0000h
6320h	CAM1 high limit	00h	Upper switching point for the 1st CAM	Unsigned8	co	no	01h
		01h	Change of the upper switching point for the 1st CAM	Signed32	rw		0000 0000h
6321h	CAM2 high limit	00h	Upper switching point for the 2nd CAM	Unsigned8	co	no	01h
		01h	Change of the upper switching point for the 2nd CAM	Signed32	rw		0000 0000h
6322h	CAM3 high limit	00h	Upper switching point for the 3rd CAM	Unsigned8	co	no	01h
		01h	Change of the upper switching point for the 3rd CAM	Signed32	rw		0000 0000h
6323h	CAM4 high limit	00h	Upper switching point for the 4th CAM	Unsigned8	co	no	01h
		01h	Change of the upper switching point for the 4th CAM	Signed32	rw		0000 0000h
6324h	CAM5 high limit	00h	Upper switching point for the 5th CAM	Unsigned8	co	no	01h
		01h	Change of the upper switching point for the 5th CAM	Signed32	rw		0000 0000h
6325h	CAM6 high limit	00h	Upper switching point for the 6th CAM	Unsigned8	co	no	01h
		01h	Change of the upper switching point for the 6th CAM	Signed32	rw		0000 0000h
6326h	CAM7 high limit	00h	Upper switching point for the 7th CAM	Unsigned8	co	no	01h
		01h	Change of the upper switching point for the 7th CAM	Signed32	rw		0000 0000h
6327h	CAM8 high limit	00h	Upper switching point for the 8th CAM	Unsigned8	co	no	01h
		01h	Change of the upper switching point for the 8th CAM	Signed32	rw		0000 0000h

Table 4.23: Device-specific objects 6315h - 6327h

Object	Name	Idx	Description	Data size (bit)	ro rw co	Map	Default
6330h	CAM1 hysteresis	00h	Hysteresis for the switching points of the 1st CAM	Unsigned8	co	no	01h
		01h	The size of the hysteresis depends on the height of this value	Unsigned3 2	rw		0000 0000h
6331h	CAM2 hysteresis	00h	Hysteresis for the switching points of the 2nd CAM	Unsigned8	co	no	01h
		01h	The size of the hysteresis depends on the height of this value	Unsigned3 2	rw		0000 0000h
6332h	CAM3 hysteresis	00h	Hysteresis for the switching points of the 3rd CAM	Unsigned8	co	no	01h
		01h	The size of the hysteresis depends on the height of this value	Unsigned3 2	rw		0000 0000h
6333h	CAM4 hysteresis	00h	Hysteresis for the switching points of the 4th CAM	Unsigned8	co	no	01h
		01h	The size of the hysteresis depends on the height of this value	Unsigned3 2	rw		0000 0000h
6334h	CAM5 hysteresis	00h	Hysteresis for the switching points of the 5th CAM	Unsigned8	co	no	01h
		01h	The size of the hysteresis depends on the height of this value	Unsigned3 2	rw		0000 0000h
6335h	CAM6 hysteresis	00h	Hysteresis for the switching points of the 6th CAM	Unsigned8	co	no	01h
		01h	The size of the hysteresis depends on the height of this value	Unsigned3 2	rw		0000 0000h
6336h	CAM7 hysteresis	00h	Hysteresis for the switching points of the 7th CAM	Unsigned8	co	no	01h
		01h	The size of the hysteresis depends on the height of this value	Unsigned3 2	rw		0000 0000h

Table 4.24: Device-specific objects 6330h - 6336h

Object	Name	Idx	Description	Data size (bit)	ro rw co	Map	Default
6337h	CAM8 hysteresis	00h	Hysteresis for the switching points of the 8th CAM	Unsigned8	co	no	01h
		01h	The size of the hysteresis depends on the height of this value	Unsigned32	rw		0000 0000h
6340h ... 6347h	High-resolution CAM 1 - 8 low limit	00h	Lower switching point for the 1st CAM	Unsigned8	co	no	01h
		01h	Change of the lower switching point for the 1st – 8th CAM	Signed64	rw		0000 0000 0000 0000h
6350h etc. 6357h	High-resolution CAM 1 - 8 high limit	00h	Upper switching point for the 1st CAM	Unsigned8	co	no	01h
		01h	Change of the upper switching point for the 1st – 8th CAM	Signed64	rw		0000 0000 0000 0000h
6360h ... 6367h	High-resolution CAM 1 - 8 hysteresis	00h	Hysteresis for the switching points of the 1st – 8th CAM	Unsigned8	co	no	01h
		01h	The size of the hysteresis depends on the height of this value	Unsigned64	rw		0000 0000 0000 0000h
6400h	Work area state register	00h	Number of status bits of the work area	Unsigned8	co	Yes	01h
		01h	Status of the area state register, 00h = in the work area, 03h above, 05h below the work area	Unsigned8	ro		00h
6401h	Work area low limit	00h	Lower limit of the work area	Unsigned8	co	no	01h
		01h	Change of the work area low limit	Signed32	rw		0000 0000h
6402h	Work area high limit	00h	Upper limit of the work area	Unsigned8	co	no	01h
		01h	Change of the work area high limit	Signed32	rw		7FFF FFFFh

Table 4.25: Device-specific objects 6337h - 6402h

Object	Name	Idx	Description	Data size (bit)	ro rw co	Map	Default
6410h	High-resolution area state register	00h	Number of status bits of the work area	Unsigned8	co	Yes	01h
		01h	Status of the high-resolution area state register, 00h = in the work area, 03h above, 05h below the work area	Unsigned8	ro		00h
6411h	High-resolution work area low limit	00h	Lower limit of the high-resolution work area	Unsigned8	co	no	01h
		01h	Change of the high-resolution work area low limit	Signed64	rw		0000 0000 0000 0000h
6412h	High-resolution work area high limit	00h	Upper limit of the high-resolution work area	Unsigned8	co	no	01h
		01h	Change of the high-resolution work area high limit	Signed64	rw		7FFF FFFF FFFF FFFFh
6500h	Operating status	00h	Contains the values from object 6000h	Unsigned16	ro	no	
6501h	Single-turn resolution	00h	Display of the single-turn resolution	Unsigned32	co	no	0001 0000h
6502h	Number of distinguishable revolutions	00h	Display of the multi-turn resolution	Unsigned32	co	no	ST: 0000 0001h MT: FFFF FFFFh
6503h	Alarms	00h	Alarm in the event of a malfunction	Unsigned16	ro	Yes	
6504h	Supported alarms	00h	Display of the alarms implemented in the encoder	Unsigned16	co	no	0001h
6505h	Warnings	00h	Warning in the event of a deviation in the operating parameters	Unsigned16	ro	Yes	
6506h	Supported warnings	00h	Display of the warnings implemented in the encoder	Unsigned16	co	no	7001h
6507h	Profile and software version	00h	The first 4 digits = software version, the next 4 digits = profile	Unsigned32	co	no	0100 0400h
6508h	Operating time	00h	Not supported	Unsigned32	co	no	FFFF FFFFh

Table 4.26: Device-specific objects 6410h - 6508h

Object	Name	Idx	Description	Data size (bit)	ro rw co	Map	Default
6509h	Offset value	00h	Contains the offset value, calculated from the preset function (6003h)	Signed32	ro	no	0000 0000h
650Ah	Module identification	00h	Manufacturer-specific offset	Unsigned8	co	no	03h
		01h	Manufacturer offset value	Signed32	co		0000 0000h
		02h	Manufacturer min. position	Signed32	co		0000 0000h
		03h	Manufacturer max. position	Signed32	co		ST: 0000 FFFFh MT: FFFF FFFFh
650Bh	Serial number	00h	Display the serial number of the encoder	Unsigned8	co	no	01h
		01h	Serial number	Unsigned32	co		
650Dh	Absolute accuracy	00h	Absolute accuracy	Unsigned8	co	no	0Ch
650Eh	Device capability	00h	Contains additional information on object 1000h	Unsigned32	ro	no	0000 000Bh
650Fh	Offset value for high-resolution encoder	00h	Contains the offset value, calculated from the preset function (6009h)	Unsigned8	co	no	01h
		01h		Signed64	ro		0000 0000 0000 0000h
6510h	Number of high-precision revolutions	00h	Display of the max. possible high-precision multi-turn resolution	Unsigned40	co	no	00FF FFFF FFFFh

Table 4.27: Device-specific objects 6509h - 6510h

4.3.4.1 6000h – Operating parameters

	<ul style="list-style-type: none"> To be able to adapt the resolution of the encoder, the "Scale" option must be enabled. In the same process, the direction of revolution and counting can be defined, i.e. it is possible to specify whether the counting-up of positions occurs when the shaft revolves (view of the shaft with flange) in a clockwise or anti-clockwise direction (default = clockwise). After a power reset, object 6000h can have other values than shown in Table 4.28. That has to do with internal settings for the high precision value, but it is enough to use the values shown here.
---	---

The settings are made in object 6000h sub-index 00h. A list of the possible configurations is set out below:

Code byte 0	Scaling	Direction of revolution
00h (default)	Off	Clockwise
01h	Off	Anti-clockwise
04h	On	Clockwise
05h	On	Anti-clockwise

Table 4.28: Direction of revolution and scaling parameters

4.3.4.2 6001h – Measuring units per revolution

The single-turn resolution is changed with object 6001h.

4.3.4.3 6002h – Total measuring range

The total resolution is set via object 6002h. This object accepts a total resolution up to ≤ 32 bits. If a higher total resolution is to be set > 32 bits, this must be set in object 600Ah (see 4.3.4.8).

	<ul style="list-style-type: none"> TMR always uses the last value set e.g. 600Ah was set last, TMR = the value of 600Ah, if 6002h is changed afterwards, TMR = the value of 6002h.
---	--

4.3.4.4 6003h – Preset value

The displayed measured value can be adjusted using the setting of index 6003h. This means that the zero-point of the encoder can be aligned with the zero-point of your application. To do this, integrate the encoder into your application, then write the desired position value in object 6003h that the encoder is to output in the current shaft position.

4.3.4.5 6004h – Position value

The current scaled position value is output via object 6004h.

4.3.4.6 6008h – High-precision position value

See 4.3.4.5, only with max. 64 bit instead of max. 32 bit

4.3.4.7 6009h – High-precision preset value

See 4.3.4.4, only with max. 64 bit instead of max. 32 bit

4.3.4.8 600Ah – High-resolution total measuring range

See 4.3.4.3 (please check hint), only with max. 64 bit instead of max. 32 bit

4.3.4.9 600Bh – High-resolution position raw value

See 4.3.4.10, only with max. 64 bit instead of max. 32 bit

4.3.4.10 600Ch – Position raw value

The current **non**-scaled position value is output without a preset via object 600Ch.

4.3.4.11 6030h – Speed value

The current determined speed is output via object 6030h. The speed is influenced by the parameters defined under 4.3.4.12.

4.3.4.12 6031h – Speed parameters

The speed source selector can be set as follows

Sub-Idx	Type	Access	Meaning	Value
0	Unsigned8	ro	Number of objects	4
1	Unsigned8	rw	Speed source selector 1: Objekt 6004 (position value) 2: Objekt 600C (raw Position value) 3: Objekt 6008 (high resolution position value) 4: Objekt 600B (high resolution raw position value)	3
2	Unsigned16	rw	Speed integration time Time divisor for speed calculation in ms	100
3	Unsigned16	rw	Multiplier value	1
4	Unsigned16	rw	Divider value	1

Table 4.29: Speed selector

The speed integration time determines the time interval for calculating the speed. It is specified in milliseconds, e.g. 64h = 100 ms

Together, multipliers and dividers represent a freely configurable factor. They can be used to convert increments per second into millimetres per minute, for example.

4.3.4.13 6300h – CAM state register

The CAM state register (object 6300h) is used to represent the cam switching states depending on the position of the encoder shaft. To do this, the value of the register must be broken down into binary notation (see below). Each bit of the octet from object 6300h shows the status of a specific switch position.

The following example shows a CAM state register with the value 89h:

Position	7(MSB)	6	5	4	3	2	1	0(LSB)
Type	CAM 8	CAM 7	CAM 6	CAM 5	CAM 4	CAM 3	CAM 2	CAM 1
Value	1	0	0	0	1	0	0	1
Logic	High	Low	Low	Low	High	Low	Low	High

Table 4.30: CAM state register - value 89h

As can be seen from the above, value 89h defines that the cam switch positions CAM 1, CAM 4 and CAM 8 are high and the remaining cams are low. When the shaft turns further, it could happen that ultimately CAM 4 also becomes low. In this case, the value of the CAM state register = 81h:

Position	7(MSB)	6	5	4	3	2	1	0(LSB)
Type	CAM 8	CAM 7	CAM 6	CAM 5	CAM 4	CAM 3	CAM 2	CAM 1
Value	1	0	0	0	0	0	0	1
Logic	High	Low	Low	Low	Low	Low	Low	High

Table 4.31: CAM state register - value 81h

The independent switching of each individual CAM means that different states can be created within an object and sub-indices 256 that can be used to control machines.

4.3.4.14 6301h – CAM enable register

Every cam switch position of the CAM channel in the encoder must be "engaged" individually for use. The individual CAMs are "engaged" by writing the appropriate value into object 6301h sub-index 01h. The correct value can be found by setting the bit for each cam switch position that is supposed to be active to 1 in binary notation. If only CAM 2, CAM 4 and CAM 7 are supposed to be active, for example, then according to the binary notation:

Position	7(MSB)	6	5	4	3	2	1	0(LSB)
Type	CAM 8	CAM 7	CAM 6	CAM 5	CAM 4	CAM 3	CAM 2	CAM 1
Value	0	1	0	0	1	0	1	0

Table 4.32: CAM enable register - value 4Ah

This corresponds to the value 4Ah. If this is written into object 6301h sub-index 01h, only the cam switch positions CAM 2, CAM 4 and CAM 7 are active and able to change depending on their configuration.

4.3.4.15 6302h – CAM polarity register

The CAM polarity register in object 6302h sub-index 01h allows the polarities of every cam switch position in the CAM channel to be changed. By default, the polarity is set so that all cam switch positions "jump" to high (= 1b) when their position values are at their limits (default = 00000000b = 00h). By changing the individual bits, the individual polarities of the cam positions can be changed. This means that, at a value of 13h (= 00010011b), CAM 1, CAM 2 and CAM 6 are inverted (bit = 0b (low) if the position value is within the limits).

Position	7(MSB)	6	5	4	3	2	1	0(LSB)
Type	CAM 8	CAM 7	CAM 6	CAM 5	CAM 4	CAM 3	CAM 2	CAM 1
Value	0	0	0	1	0	0	1	1
Logic	Default	Default	Default	Inverted	Default	Default	Inverted	Inverted

Table 4.33: Example of the CAM polarity register

4.3.4.16 6310h ... 6317h – CAM1...CAM8 low limit

The lower switching point of a cam switch position is defined via the CAM low limit. Each individual cam switch position (CAM 1 ... CAM 8) has its own CAM low limit object (see object index 6310h ... 6317h).

	<ul style="list-style-type: none">• The CAM low limit can only be configured, i.e. its value changed, if the CAM high limit of the same CAM has already been set. The following applies: The value of the CAM low limit must be smaller than the value of the CAM high limit
---	--

4.3.4.17 6320h ... 6327h – CAM1...CAM8 high limit

The upper switching point of a cam switch position is defined via the CAM high limit. Each individual cam switch position (CAM 1 ... CAM 8) has its own CAM high limit object (see object index 6320h ... 6327h).

4.3.4.18 6330h ... 6337h – CAM1...CAM8 hysteresis

The CAM hysteresis is used to define the width of the hysteresis of the switching points. For each individual cam switch position (CAM 1 ... CAM 8), a separate CAM hysteresis can be set (see object index 6320h ... 6327h).

4.3.4.19 6340h ... 6347h – High-resolution CAM1...CAM8 low limit

See 4.3.4.16, only with max. 64 bit instead of max. 32 bit

4.3.4.20 6350h ... 6357h – High-resolution CAM1...CAM8 high limit

See 4.3.4.17, only with max. 64 bit instead of max. 32 bit

4.3.4.21 6360h ... 6367h – High-resolution CAM1...CAM8 hysteresis

See 4.3.4.18, only with max. 64 bit instead of max. 32 bit

4.3.4.22 6400h – Work area state register

The work area functionality is similar to the CAM functionality. It is used to indicate the exiting of a pre-defined work area. The switching points do not have a hysteresis and if the lower limit is not reached or the upper limit is exceeded, separate signals are produced.

Status of the area state register, 00h = in the working area, 03h above the value of object 6402h and 05h below the value of object 6401h.

4.3.4.23 6401h - Work area low limit

Object 6401h sub-index 01 is used to define the lower limit of the work area.

4.3.4.24 6402h – Work area high limit

Object 6402h sub-index 01 is used to define the upper limit of the work area.

4.3.4.25 6410h – High-resolution area state register

See 4.3.4.22, only with max. 64 bit instead of max. 32 bit

4.3.4.26 6411h – High-resolution work area low limit

See 4.3.4.23, only with max. 64 bit instead of max. 32 bit

4.3.4.27 6412h – High-resolution work area high limit

See 4.3.4.24, only with max. 64 bit instead of max. 32 bit

4.3.4.28 6500h – Operating status

Object 6500h (read-only) can be used to read out the set parameters of object 6000h.

4.3.4.29 6501h – Single-turn resolution

Object 6501h can be used to read out the maximum number of increments per revolution. (Single-turn resolution)

4.3.4.30 6502h – Number of distinguishable revolutions

Object 6502h can be used to read out the maximum number of distinguishable revolutions. (Multi-turn resolution)

4.3.4.31 6503h – Alarms

Object 6503h shows a possible position error (see Table 4.34)

15(MSB) ... 1	0(LSB)
Always 0	Bit 0 = 1: Position error An error has occurred in the sensor. The position value is incorrect.

Table 4.34: 6503h – Alarms

4.3.4.32 6504h – Supported alarms

Object 6504h shows the supported alarms. Only the position error is supported, therefore the value is always 0x0001h.

4.3.4.33 6505h – Warnings

Object 6505h outputs the status of the supported warnings.

Signal	6505h – Warnings									
Bit	15 ... 9	8	7	6	5	4	3	2	1	0
Contents										
15 ... 9	Not used			Always 0						
8	Jerk range			always 0, since object 6050h is not supported						
7	Acceleration range			always 0, since object 6040h is not supported						
6	Speed range			Is set if the value range of object 6030h is insufficient to represent the speed.						
5	Reference point			Always 0						
4	Battery charge			always 0, since no battery is being used						
3	Operating time limit			Always 0						
2	CPU watchdog status			always 0, not supported						
1	Light control			Always 0, not optical, but rather magnetic sensors						
0	Frequency exceeded			Is set if the speed defined in object 2107h is exceeded. Is deleted as soon as the speed falls below this limit again.						

Table 4.35: Signal description

4.3.4.34 6506h – Supported warnings

Object 6506h shows the supported warnings. Frequency exceeded and Speed range are supported, therefore always 0x0041h.

4.3.4.35 6507h – Profile and software version

Object 6507h specifies the software version and profile.

Byte	Meaning	Example
4 (MSB)	Profile Version Major	04h = Version 04.00
3	Profile Version Minor	
2	Software Version Major	01h = Version 01.64
1	Software Version Minor	

Table 4.36: Example of profile software version

4.3.4.36 6508h – Operating time

Object 6508h is not supported.

4.3.4.37 6509h – Offset value

Object 6509h contains the offset value, calculated from the preset function (6003h).

4.3.4.38 650Ah – Module identification

Using object 650Ah, sub-indices 01-03h can be used to read out the device-specific parameters (manufacturer offset, manufacturer min. position, manufacturer max. position).

4.3.4.39 650Bh – Serial number

Object 650Bh contains the serial numbers of the encoder.

4.3.4.40 650Dh – Absolute accuracy

Object 650Dh can be used to read out the absolute accuracy of the sensor in bits. Currently this value is 12 bits.

4.3.4.41 650Eh – Device capability

The object 650Eh contains additional information on object 1000h. The default is 0000 000Bh. This states that the encoder is a class 3 high-resolution encoder without safety functions.

4.3.4.42 650Fh – Offset value for high-resolution encoder

Object 650Fh contains the offset value for high-resolution encoders, calculated from the preset function (6009h).

4.3.4.43 6510h – Number of high-precision revolutions

Object 6510h specifies the number of revolutions distinguishable by the sensor. Currently the value is FF FFFF FFFFh.



- The specification defines this parameter as an Unsigned40 value. The Wachendorff encoder is able to discern 43-bit revolutions, however, and transfer this value.

5 Web server

5.1 General

The EtherCAT encoders have a web server where you can view or adjust information and configurations. To reach the web server, call up its set IP address using a browser of your choice (Internet Explorer, Firefox, etc.). To do this, connect the encoder via an Ethernet cable (M12 plug to the encoder and RJ45 plug to the PC) to your computer. Ensure that your PC is installed in the same IP address range as the encoder and that TwinCAT is active.



- Example configuration:
Encoder IP address: 192.168.1.127
PC IP address: 192.168.1.100
PC sub-net address: 255.255.255.0

Once you have done this, the encoder's start page opens (Information - Summary).

In the sub-sections below, we show you the various views of the web server and explain the possible functions to you.

5.2 Information

5.2.1 Summary

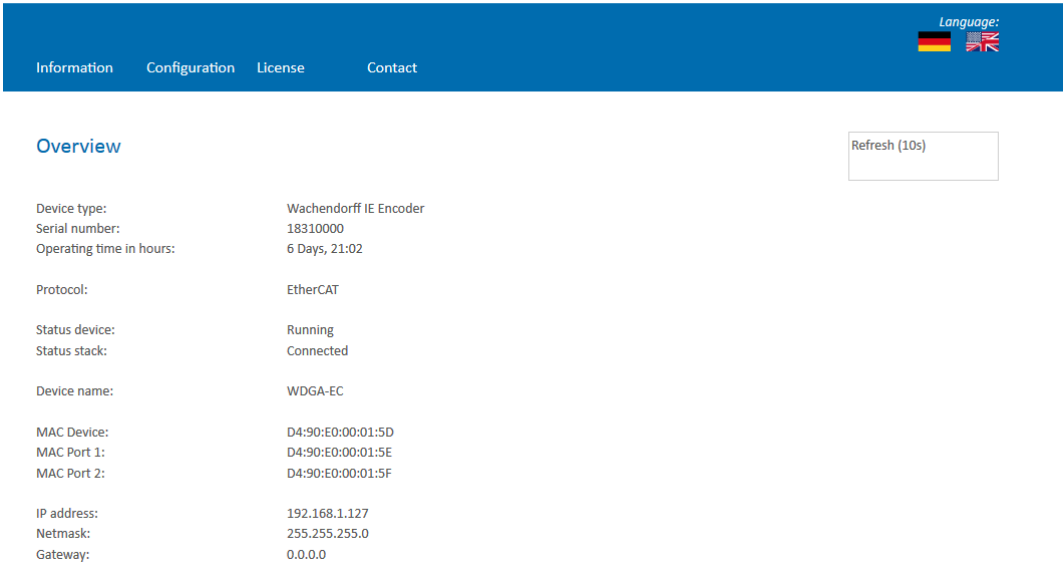

Overview	
Device type:	Wachendorff IE Encoder
Serial number:	18310000
Operating time in hours:	6 Days, 21:02
Protocol:	EtherCAT
Status device:	Running
Status stack:	Connected
Device name:	WDGA-EC
MAC Device:	D4:90:E0:00:01:5D
MAC Port 1:	D4:90:E0:00:01:5E
MAC Port 2:	D4:90:E0:00:01:5F
IP address:	192.168.1.127
Netmask:	255.255.255.0
Gateway:	0.0.0.0

Figure 5.1: Web server – Summary

The summary contains the following information:

- Device type: Designation of the encoder
- Serial number: Device number of the encoder
- Operating time in hours: Number of hours of current operation
- Protocol: EtherCAT
- Device status: On or Off state
- Status stack: Online or offline
- Device name: Name of EtherCAT device
- MAC devices: Encoder MAC address
- MAC port 1: MAC address of Ethernet port 1
- MAC port 2: MAC address of Ethernet port 2
- IP address: IP address of your EtherCAT encoder
- Network mask: Sub-net mask of your EtherCAT encoder
- Gateway: Gateway of your EtherCAT encoder

The website's refresh rate is fixed at 10 seconds and cannot be changed. Using the message: "Refresh data" at the top right in the field showing the update time, you can see that the data is currently being updated.

You can toggle the language of the web server after you call it up. After switching in a sub-mask, the web server restarts in the start mask.

5.2.2 Diagnosis

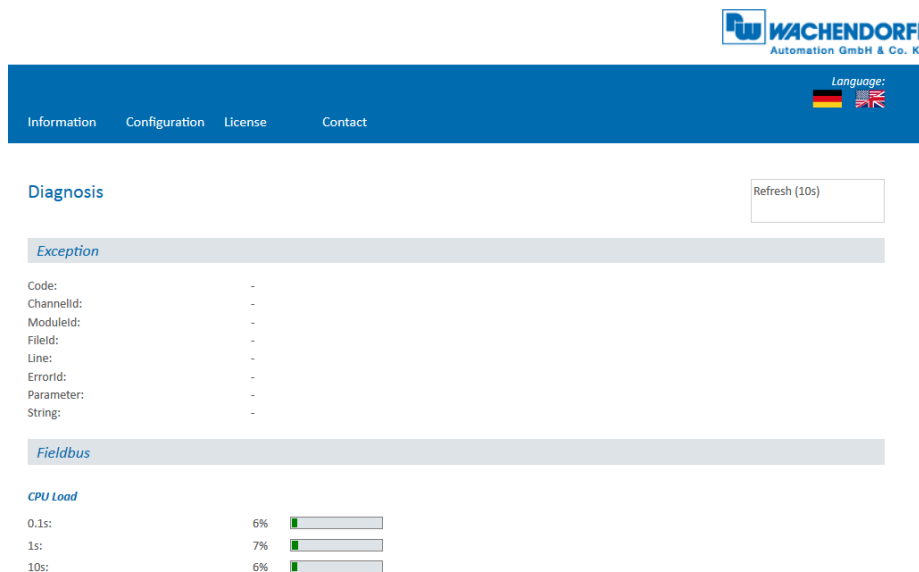

Figure 5.2: Diagnostics page

Exception

This is where possible causes of errors can be displayed. If you see an error here, contact us and tell us what the information says.



Field bus

- CPU load: This is where you will see the CPU load of the encoder in operation.

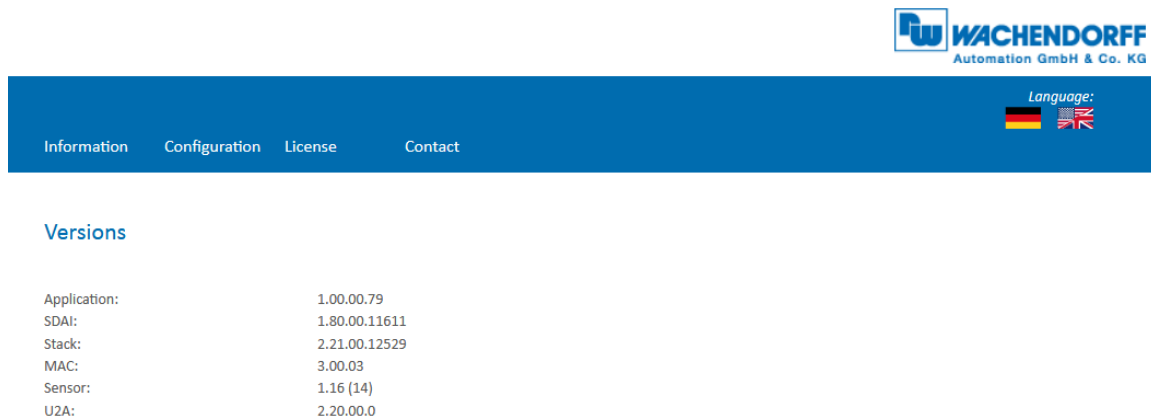
5.2.3 Versions



 **WACHENDORFF**
Automation GmbH & Co. KG

Language:  

Information Configuration License Contact

Versions

Application:	1.00.00.79
SDAI:	1.80.00.11611
Stack:	2.21.00.12529
MAC:	3.00.03
Sensor:	1.16 (14)
U2A:	2.20.00.0

Figure 5.3: Versions

Figure 5.3 shows information about the individual version states such as:

- Application
- SDAI
- Stack
- MAC
- Sensor
- U2A

5.3 Configuration

5.3.1 Network

Language:  

Information Configuration License Contact

Network

Device name:

IP address:

Netmask:

Gateway:

Warning: Changes only at downtimes

Figure 5.4: Network settings

This is where you can change the device name, IP address, network status and gateway.

	<ul style="list-style-type: none">• Please note that you can only change the data when the system is not moving.
---	--

5.3.2 Encoder



Encoder

Current Values

Position Value:	576460752303402900
Raw Position Value	20604
Position Offset:	0
Velocity:	0
CAM Status:	0
Work Area Status:	2

Figure 5.5: Encoder information

You can check the parametrised values of the encoder in Figure 5.5:

- Position (with scaling)
- RAW position (without scaling)
- Offset
- Velocity
- CAM status
- Work area status

5.3.3 Firmware update

To perform a firmware update, first establish a connection with the encoder as described in chapter 6.1 and make sure that the Free Run mode is activated. Now open the web server as described in chapter 5.1.

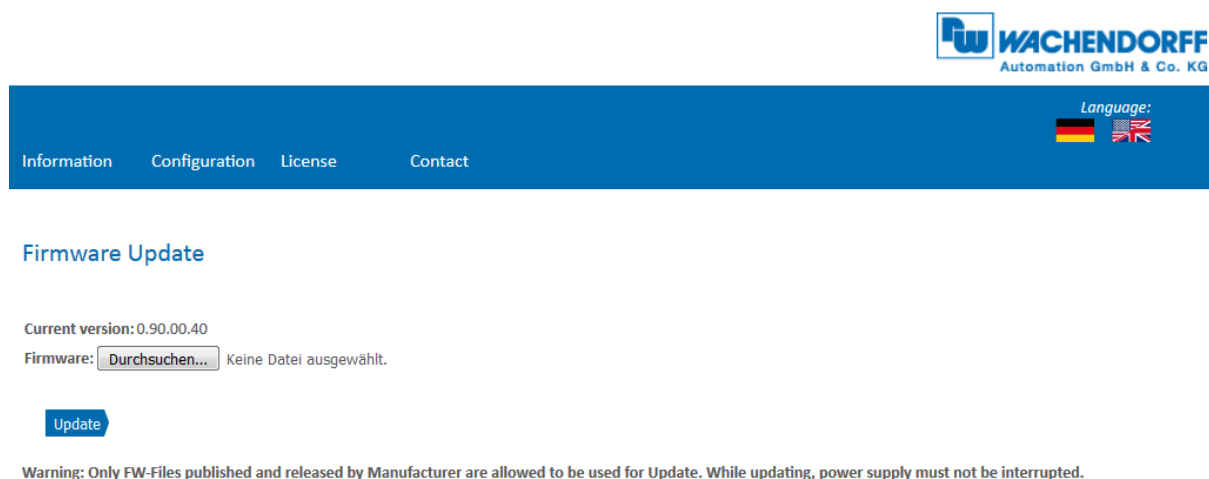



Figure 5.6: Firmware update

The encoder's current firmware version is displayed. If a new firmware version is available, you can update the version on the encoder here.

	<ul style="list-style-type: none"> • Please note that you can only carry out the firmware update when the system is not moving. • Do not disconnect the voltage supply or network cable while a firmware update is in progress.
---	---

To update the encoder's firmware, choose the valid firmware file with the ending ".bin" by pressing the "Browse..." button (see Figure 5.7).

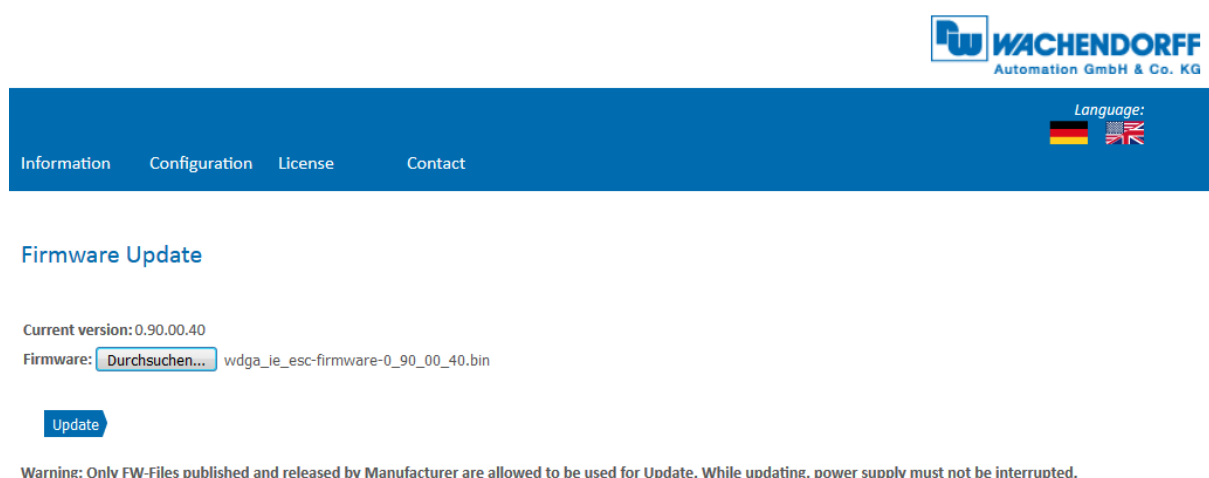

Figure 5.7: Firmware update - selecting the file

Now click the "Update" button to start the firmware update. An animated display appears showing the following text: "Transferring file" (see Figure 5.8) and after the transfer is done, you will see a warning "Updating FLASH. This takes about 2 minutes. Do not switch off the device!" (see Figure 5.9)

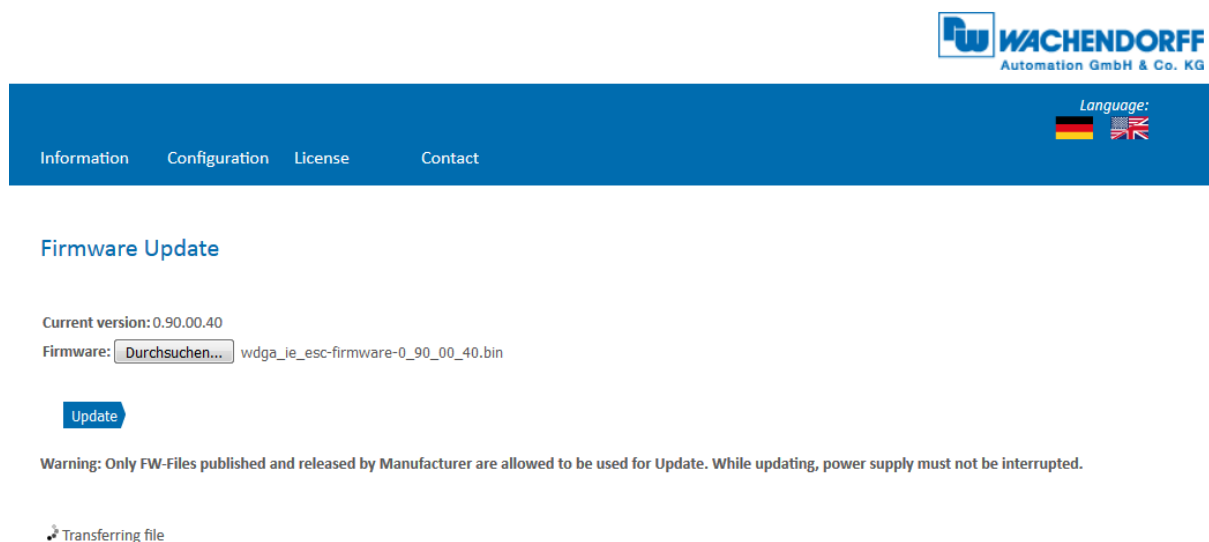

Figure 5.8: Firmware update - transfer file

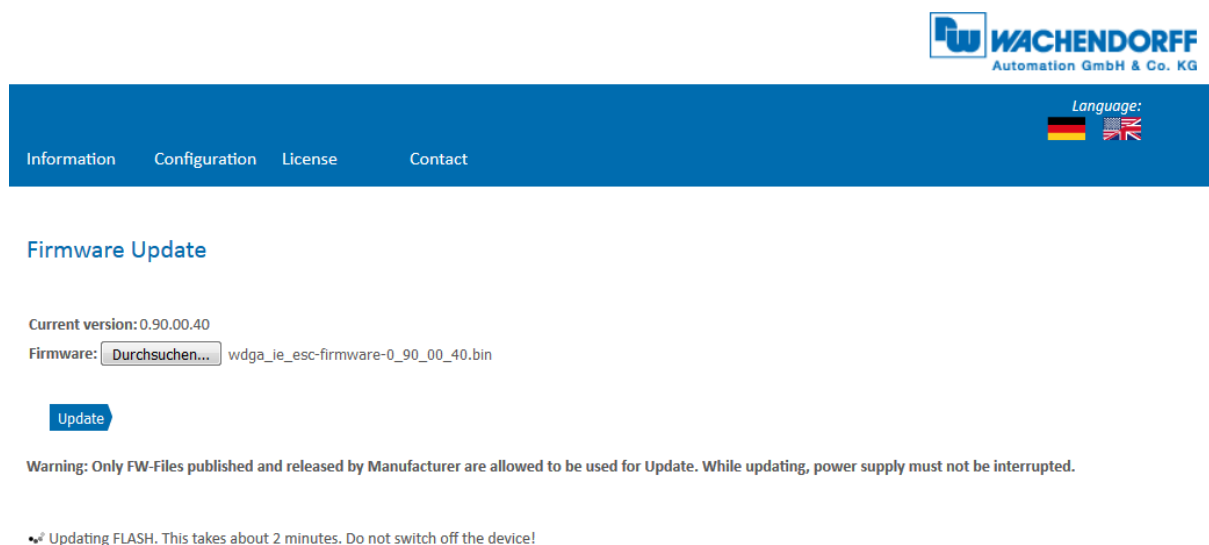

Figure 5.9: Firmware update – update FLASH

If the firmware update was carried out successfully, this is indicated as shown in Figure 5.10. Now carry out a voltage reset and then check under Information -> Versions whether the new firmware version is displayed.

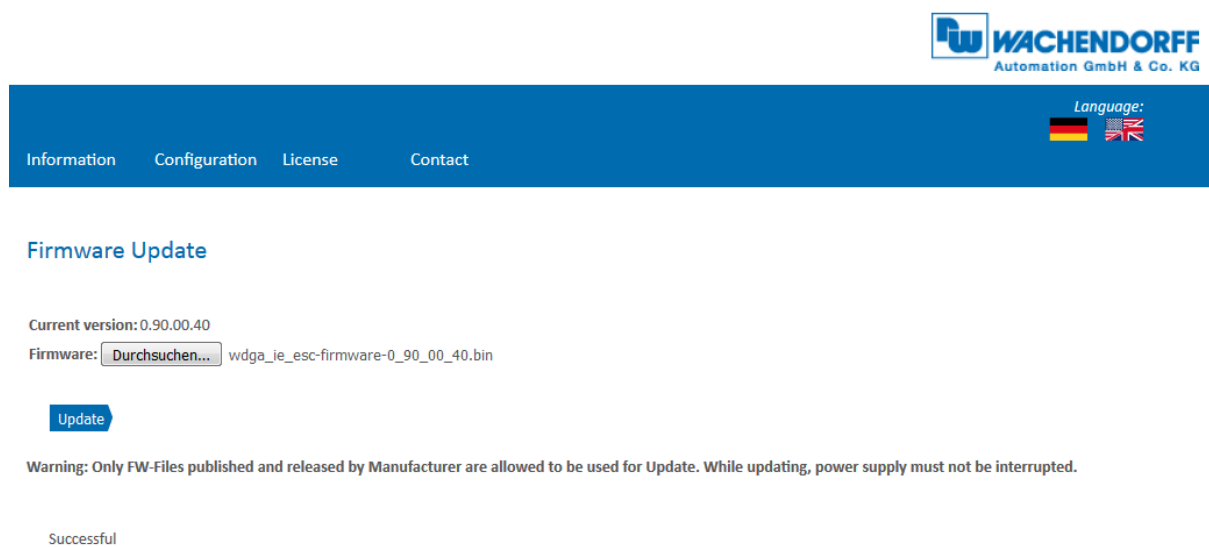

Figure 5.10: Firmware update - successful

If the firmware update fails (see Figure 5.11), please check that you have selected the correct file. Carry out a voltage reset and repeat the process. If the voltage supply fails during the update and the encoder stops responding, please contact our support team.

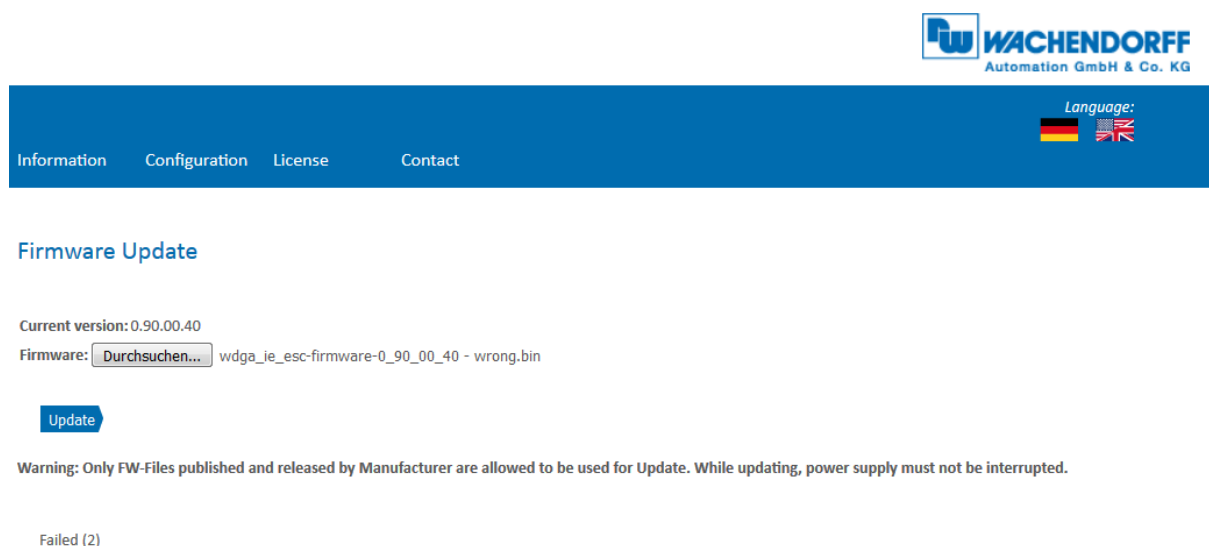

Figure 5.11: Firmware update - failed

5.4 Licence information

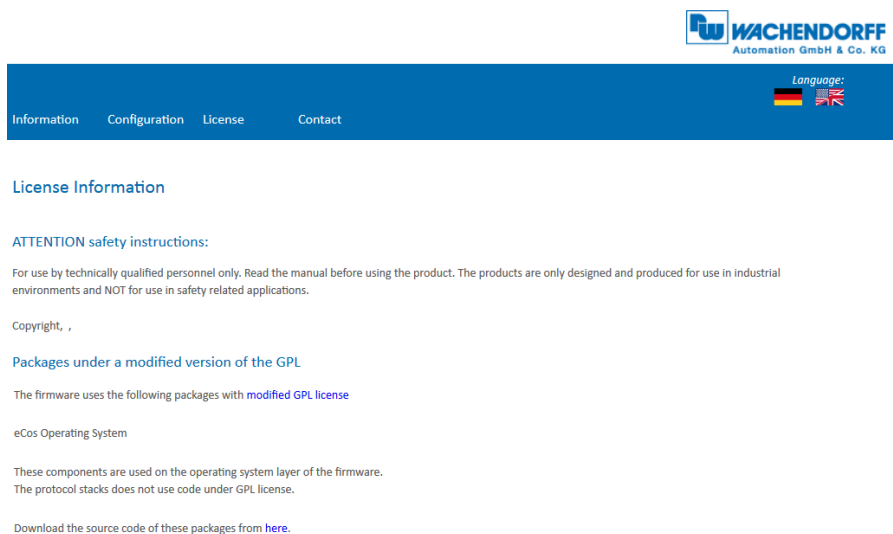

Figure 5.12: Licence information

This is where you will find the current safety instructions, as well as firmware program packages. You can download the source code of these packages via the link on this website.

5.5 Contact

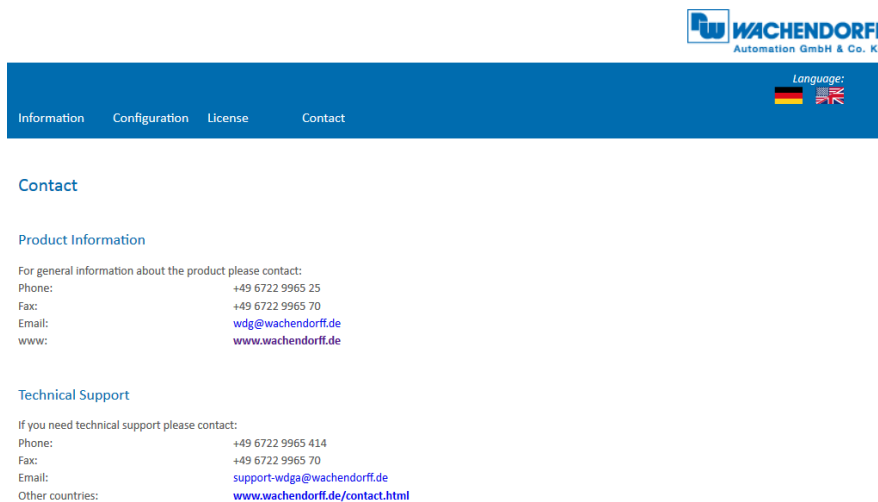

Figure 5.13: Contact information

For further product information and technical support, you will find the contact details required here.

6 TwinCAT 3

6.1 Commissioning



- The XML file must be copied into the following directory:
...\\TwinCAT\\IO\\EtherCAT
- You can download the file from
www.wachendorff-automation.de

- Start TwinCAT and a new project.
- Now carry out the following steps.



- Ensure that you have an Intel network card in your PC.
TwinCAT only works reliably with certain types.

- Expand the tree at "I/O" and right-click on Device. Then click SCAN.

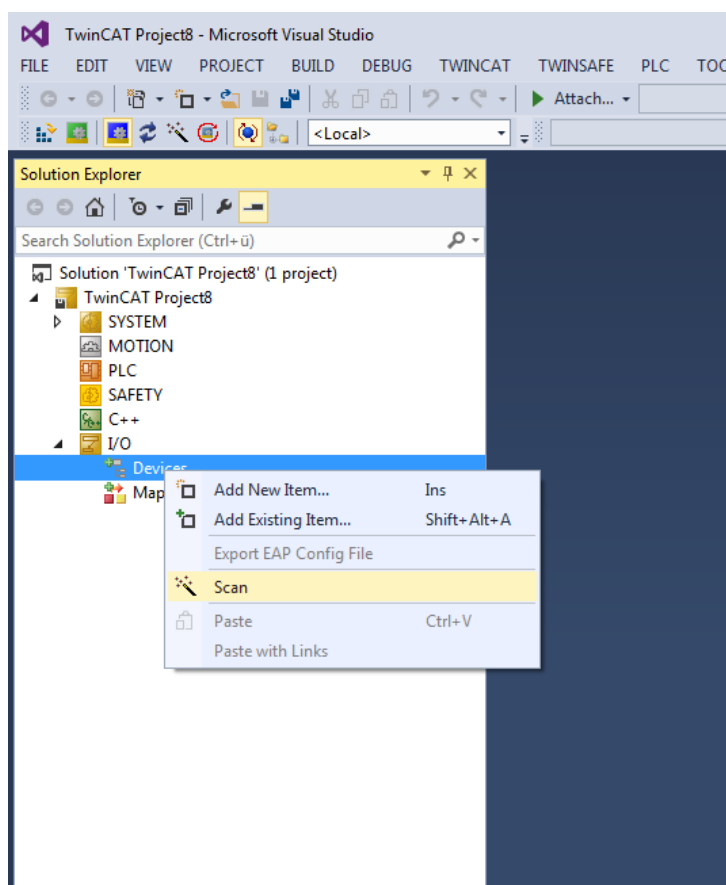

Figure 6.1: TwinCAT – Scan

- Confirm the message shown in Figure 6.2 with "OK".

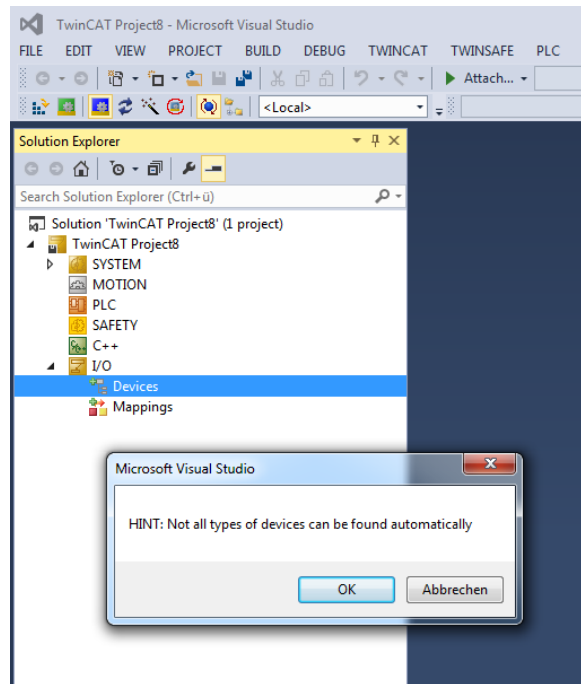

Figure 6.2: TwinCAT - Scan / Message

- Choose your TwinCAT-enabled network card (see Figure 6.3)

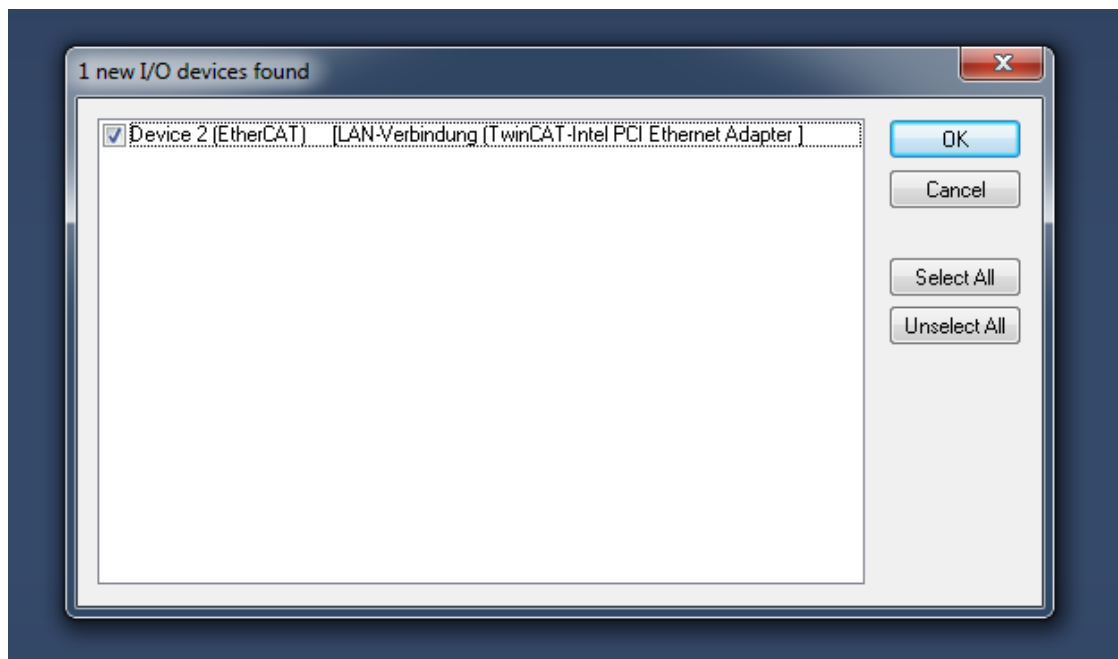

Figure 6.3: TwinCAT - IO devices

- Confirm the prompt "Scan for boxes" with "Yes" (see Figure 6.4)
- The system is scanned for EtherCAT members.

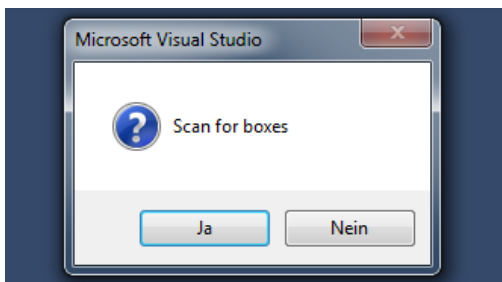

Figure 6.4: TwinCAT – Scan for boxes

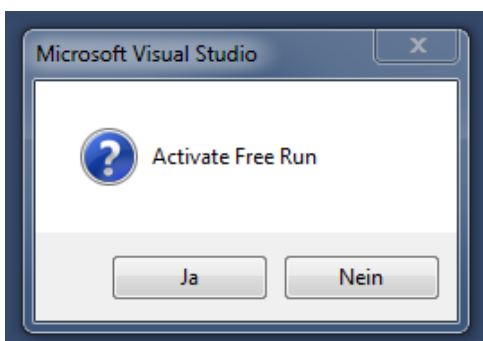

Figure 6.5: TwinCAT – Activate Free Run

- Once the scan is complete, confirm the following window with "Yes". (see Figure 6.5) The encoder appears in the tree structure and you can access the process data via the CoE tab. (see Figure 6.6)

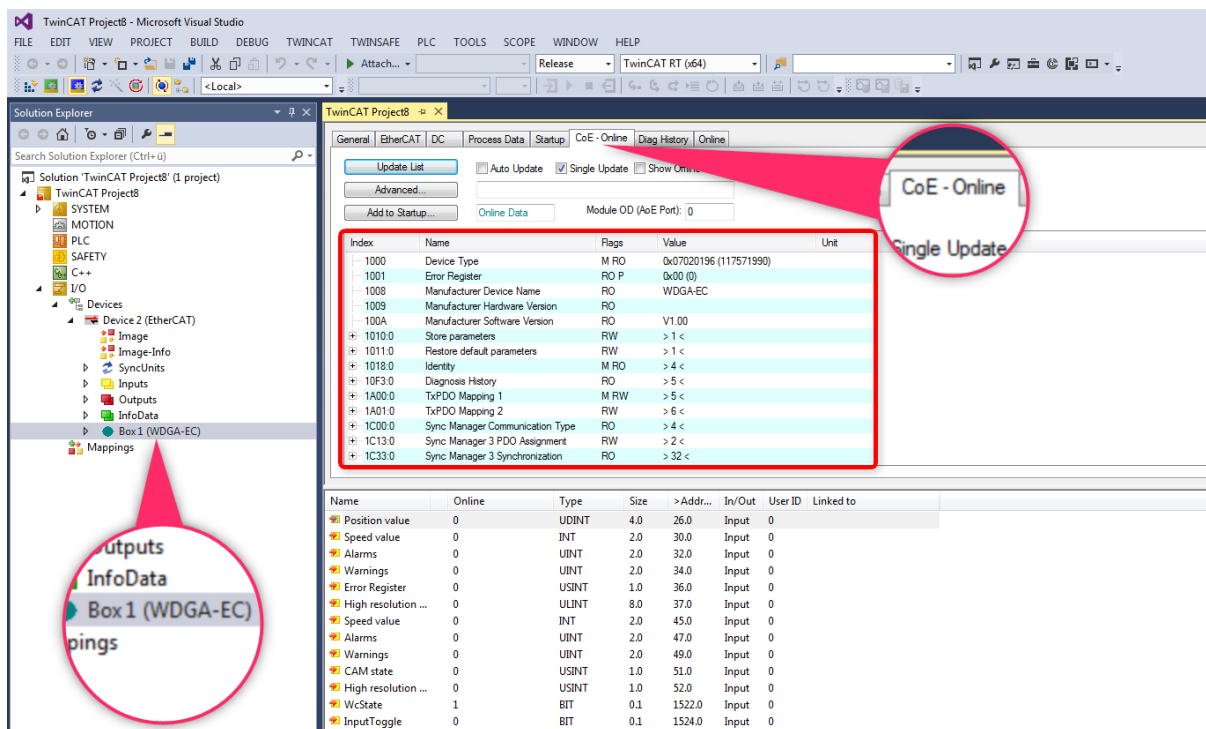

Figure 6.6: TwinCAT - Scan complete

6.2 Scaling

To use the scaling function, make sure that the object with index 6000 is set to e.g. 0x0004 in the "CoE - Online" tab. (see Figure 6.7) If not, double-click it and change the value (see Figure 6.8) to your desired setting (see 4.3.4.1 6000h – Operating parameters).

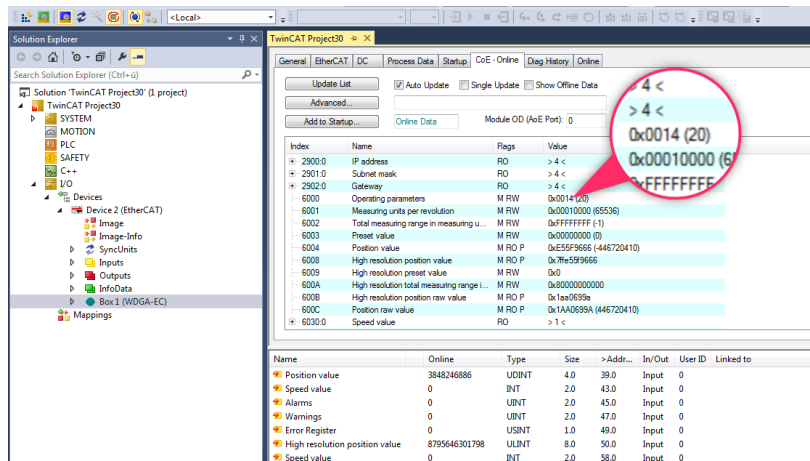

Figure 6.7: Scaling – Check object 6000

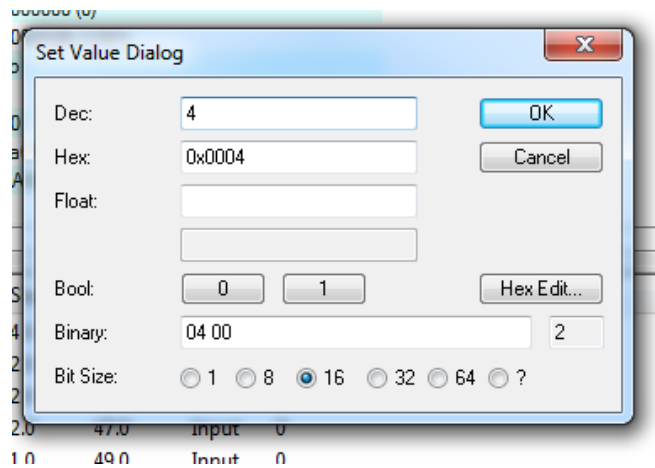

Figure 6.8: Scaling – set object 6000 to 4

Now set the resolution for singleturn and multiturn to the values you require. In this example we set the steps per revolution to 360 (see Figure 6.9) and the number of countable revolutions to 10, so the number of total steps must be set to 3600. (s. Figure 6.10)

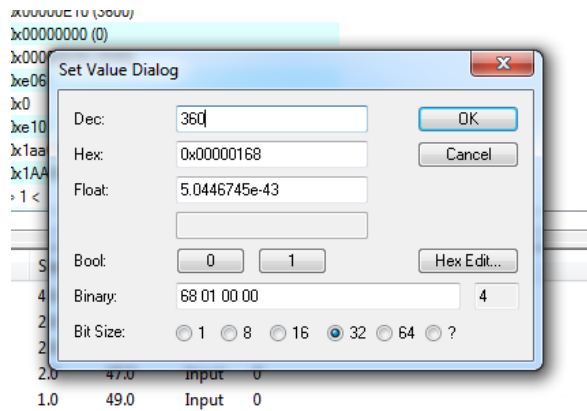

Figure 6.9: Scaling – 6001 measuring units per revolution

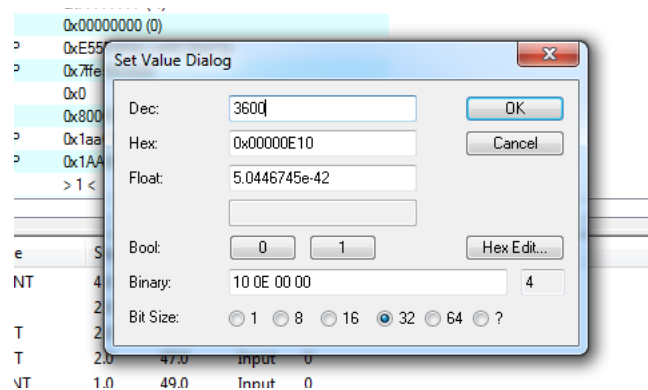

Figure 6.10: Scaling – Total measuring range in measuring units

The result should look like in Figure 6.11.

6000	Operating parameters	M RW	0x0004 (4)
6001	Measuring units per revolution	M RW	0x00000168 (360)
6002	Total measuring range in measuring u...	M RW	0x00000E10 (3600)
6003	Preset value	M RW	0x00000000 (0)
6004	Position value	M RO P	0x0000050C (1292)
6008	High resolution position value	M RO P	0x50c
6009	High resolution preset value	M RW	0x0
600A	High resolution total measuring range i...	M RW	0xe 10
600B	High resolution position raw value	M RO P	0x1aa06999
600C	Position raw value	M RO P	0x1AA06999 (446720409)

Figure 6.11: Scaling - Overview of the example settings

To ensure that the values are saved after a voltage reset, please read Chapter 6.4 Save settings.

6.3 Preset

To set a preset, you must set the desired value to the object with index 6003. Double-click object 6003 in the tab "CoE - Online". Enter the desired value (in the example "0") and confirm with OK. Figure 6.12 shows the value before the preset. Figure 6.13 shows that the preset has been accepted.

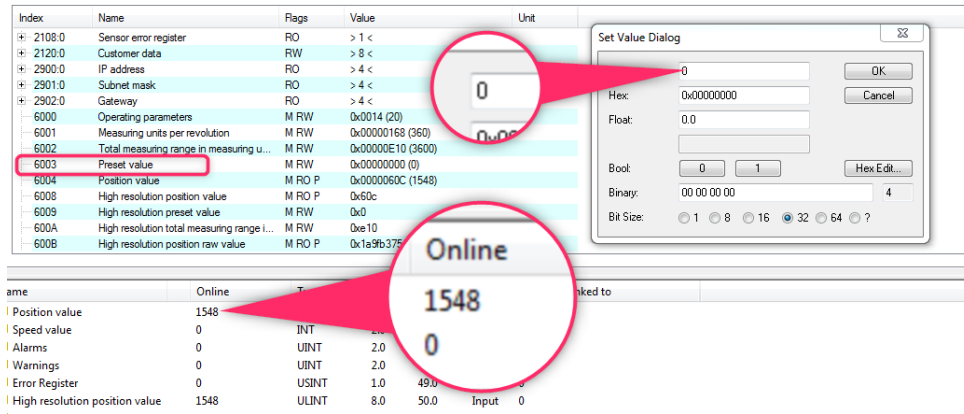

Figure 6.12: Preset – Set to zero

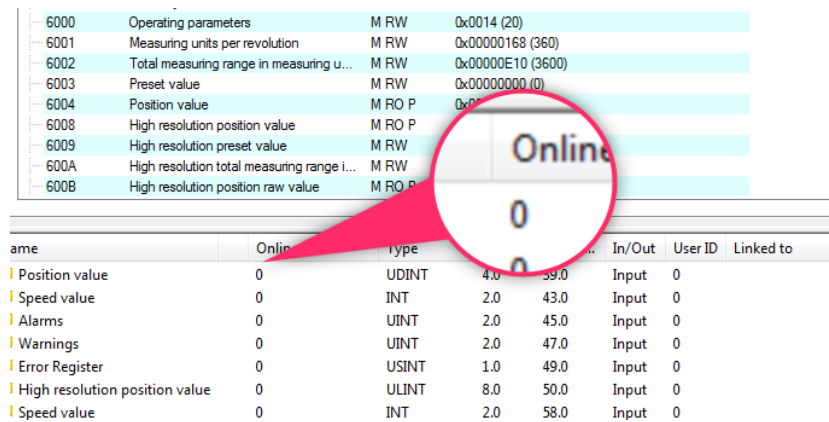



Figure 6.13: Preset – Preset accepted

To ensure that the values are saved after a voltage reset, please read Chapter 6.4 Save settings.



- When the preset is executed, an offset value is calculated and stored in the encoder. The offset value is reset as soon as the scaling of the encoder changes. This ensures that an offset value is not used that may not match the set scaling.

6.4 Save settings

To ensure that settings are retained even after a voltage reset, the values must be saved. This is done by setting the value of object 1010:01 to 1702257011 as "Dec:" and confirming with OK (see Figure 6.14). This corresponds to the word "save".

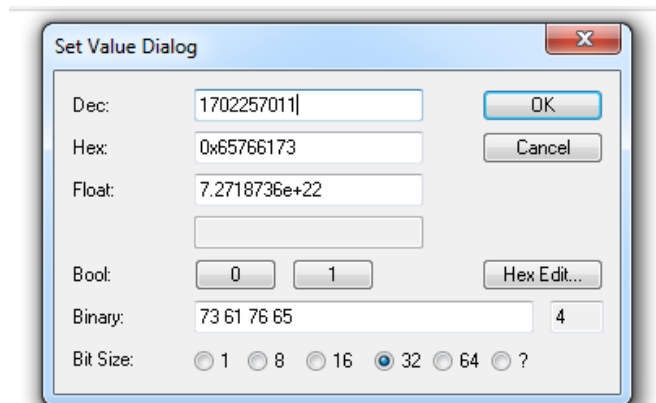

Figure 6.14: Save settings

7 Technical advice

Technical applications advisers

Do you have any questions about this product?

Your technical applications advisers will be happy to help you.

Tel.: +49 (0) 67 22 / 99 65 414
E-mail: support-wa@wachendorff.de

Notes: